

**MQ15-X- Power male receptacle front mount**

PVC 6x2,5 UL/CSA 1,0m

Flange male

MQ15, 6-pole

with multi-strand wire

Front mounting

Plastic housings with good resistance against chemicals and oils.

The resistance to aggressive media should be individually tested for your application. Further details on request.

Further cable lengths on request.

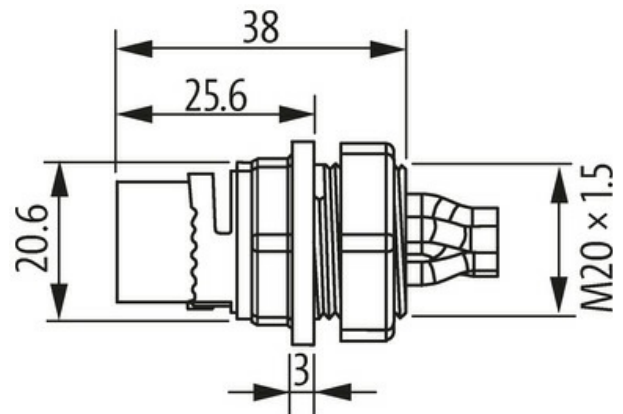
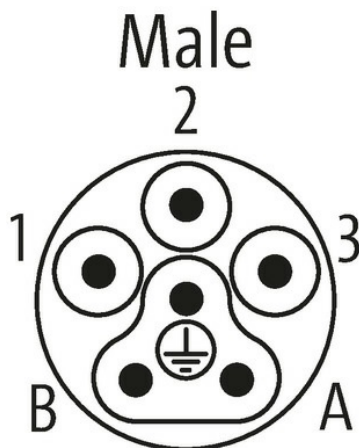
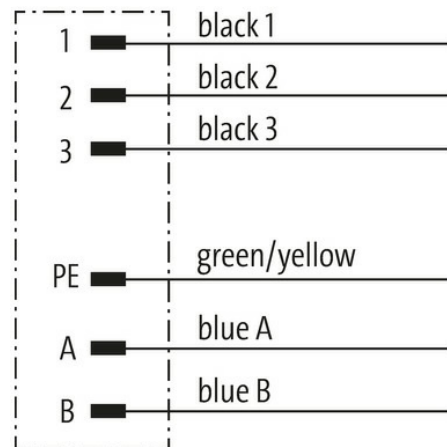
**[Link to Product](#)****Illustration**

Product may differ from Image

**Form**

Form P8181

**Technical Data**

Operating voltage	max. 600 V AC (Power); max. 63 V AC/DC (Signal)
Rated surge voltage	2.5 kV
Operating current per contact	max. 16 A (Power); max. 10 A (Signal)
No. of poles	6
Material group	IEC 60664-1, category I

Mating cycles	≥ 500
LED display	no
Locking of ports	Quick connection, 1/4 turn
Protection	IP67 inserted and tightened (EN 60529)
Protection NEMA	3, 4, 6P (UL 50E)
Material	Brass, nickel plated
Configuration	fully used

**General data**

Mounting method	inserted, tightened
Material (contact)	Copper alloy
Material (contact surface)	Ag
Pollution Degree	3
Temperature range	-40...+70 °C, depending on cable quality
Material (contact carrier)	PA

**Cables**

No./diameter of wires	6× 2.5 mm <sup>2</sup>
Wire isolation	PVC (bk, bl, num, gnye)
Outer Ø	3.7 mm ±5%
Cable identification	P80
Cable number	P80
Material (wire)	Cu wire, tin plated
Construction (core)	multi-strand wire class 5 (EN 60228)
Diameter (core)	6× 2.5 mm <sup>2</sup>
AWG	similar to AWG 14
Material (wire isolation)	PVC
Wire-Ø incl. isolation	3.7 mm ±5%
thermal resistance	flame retardant UL VW1, CSA FT1
Nominal voltage	600 V
Test voltage	2500 V AC

**Commercial data**

country of origin	DE
customs tariff number	85444290
EAN	4048879590877
eClass	27279220
Packaging unit	1.000