

M12 female recept. A-cod. rear

PUR 12x0.25 gy UL/CSA+drag ch. 2m

Flange female

M12, 12-pole

Rear mounting

Further cable lengths on request.

The resistance to aggressive media should be individually tested for your application. Further details on request.

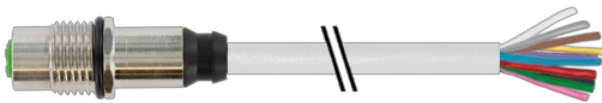
[Link to Product](#)**Illustration**

1	↷	brown
2	↷	blue
3	↷	white
4	↷	green
5	↷	pink
6	↷	yellow
7	↷	black
8	↷	gray
9	↷	red
10	↷	violet
11	↷	gray/pink
12	↷	red/blue

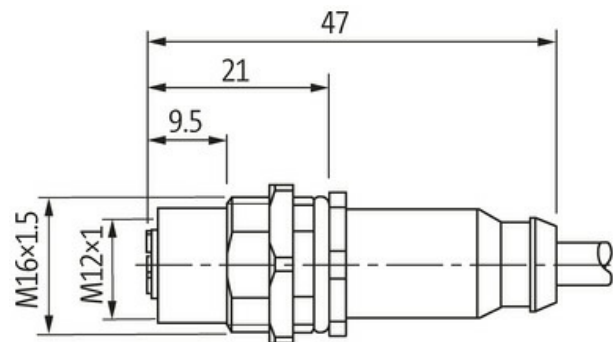
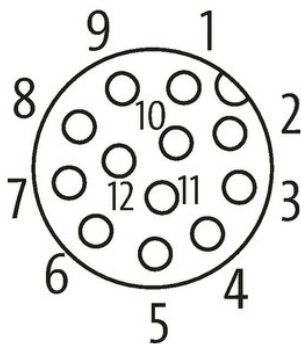
Female

Product may differ from Image

Form

Form 19197

Technical Data

Operating voltage max. 30 V AC/DC

Rated surge voltage 0.8 kV

Operating current per contact max. 1.5 A

No. of poles 12

Material group IEC 60664-1, category I

Coding A-coded

LED display no

Locking of ports	Screw thread (M12×1 mm) recommended torque 0.6 Nm, self-securing
Compression gland	M12 (SW14)
Protection	IP67 inserted and tightened (EN 60529)
Protection NEMA	3, 4, 6P (UL 50E)
Locking material	Brass, nickel plated

General data

Pollution Degree	3
Temperature range	-25...+85 °C, depending on cable quality

Cables

No./diameter of wires	12× 0.25 mm ²
Wire isolation	PP (br, bl, wh, gn, pk, ye, bk, gr, rd, vi, grpk, rdbl)
C-track properties	3 Mio.
Outer Ø	6.9 mm ±5%
Cable identification	301
Approval (cable)	UL (AWM-Style 20233/10978), CSA approbation; CE
Cable weight [g/m]	69,3 g
Material (wire)	Cu wire, bare
Resistor (core)	max. 76 Ω/km (20 °C)
Single wire Ø (core)	0.1 mm
Construction (core)	32× 0.1 mm (multi-strand wire class 6)
Diameter (core)	12× 0.25 mm ²
AWG	similar to AWG 24
Material (wire isolation)	PP
Material property (wire isolation)	CFC-, halogen-, cadmium-, silicone- and lead-free
Shore hardness (wire isolation)	50 ±5 D
Wire-Ø incl. isolation	1.25 mm ±5%
Color/numbering of wires	br, rd, gr, bk, ye, pk, gn, wh, bl, rdbl, grpk, vi
Stranding combination	Twisted wires rdbl, grpk and vi, over it all other wires are twisted
Shield	no
Material (jacket)	PUR
Shore hardness (jacket)	85 ±5 A
Outer-Ø (jacket)	6.9 mm ±5%
Color (jacket)	gray
Cable labeling	see frame delivery specifications 7000-00000-001
Jacket Color	gray
chemical resistance	good resistance to oil, gasoline and chemicals (VDE 0472 Teil 803 Test B)
Nominal voltage	300 V
Test voltage	1500 V
Current load capacity	to DIN VDE 0298-4
Temperature range (fixed)	-40...+80 °C
Temperature range (fixed)	-40...+80 °C
Temperature range (mobile)	-20...+80 °C
Temperature range (mobile)	-20...+80 °C
Bend radius (fixed)	10× outer Ø
Bend radius (moving)	15× outer Ø
Bend radius (moving)	15× outer Ø
No. of bending cycles (C-track)	max. 3 Mio. (25 °C)
Travel speed (C-track)	max. 2 m/s
Acceleration (C-track)	max. 10 m/s ²
Material (jacket)	PUR (UL/CSA)

Commercial data

country of origin	DE
customs tariff number	85444290

EAN	4048879541275
eClass	27279220
Packaging unit	1.000