

M12 male 0° / M12 female 0° A-cod. shielded

PVC 4x0.34 shielded gy 5m

Male straight – female straight
M12 – M12, 4-pole
shielded

Plastic housings with good resistance against chemicals and oils.

The resistance to aggressive media should be individually tested for your application. Further details on request.

Further cable lengths on request.

[Link to Product](#)

Illustration

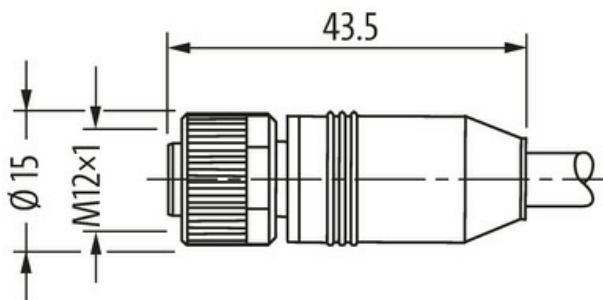
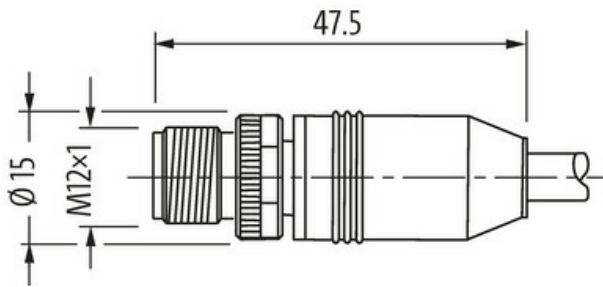
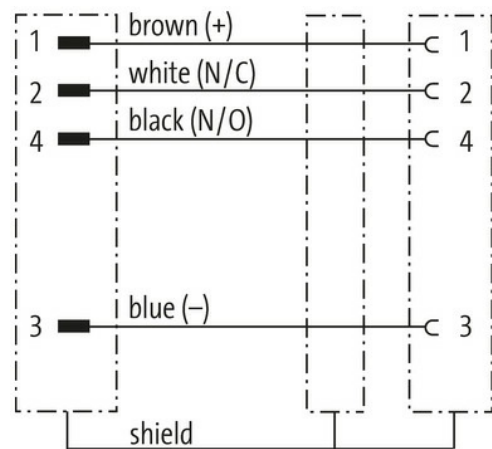

Product may differ from Image

Male

Female





* only for products with UL/CSA approved cable

Form	
Form	40501
Technical Data	
Operating voltage	max. 60 V AC/DC
Operating voltage (only UL listed)	max. 30 V AC/DC
Operating current per contact	max. 4 A
Locking of ports	Screw thread (M12×1 mm) recommended torque 0.6 Nm, self-securing
Compression gland	M12 (SW13)
Protection	IP65 and IP67 when plugged and screwed down (EN 60529)
Locking material	Zinc die casting, matte nickel plated
General data	
Standards	DIN EN 61076-2-101 (M12)
Temperature range	-25...+85 °C, depending on cable quality
Cables	
No./diameter of wires	4× 0.34 mm ²
Wire isolation	PVC (br, wh, bl, bk)
Outer Ø	5.9 mm ±5%
Cable number	330
Approval (cable)	CE conform
Shield	yes
Color (jacket)	gray
Jacket Color	gray
Temperature range (fixed)	-25...+80 °C
Temperature range (mobile)	-5...+70 °C
Bend radius (fixed)	5× outer Ø
Bend radius (moving)	15× outer Ø
Material (jacket)	PVC
Commercial data	
country of origin	DE
customs tariff number	85444290
EAN	4048879165822
eClass	27279218
Packaging unit	1.000