

M12 female 0° with cable

TPE 8x22AWG ye UL/CSA. ITC/PLTC 7.5m

USA

Female straight

M12, 8-pole

without cable sleeves

Cable is approved for 300 V

Plastic housings with good resistance against chemicals and oils.

The resistance to aggressive media should be individually tested for your application. Further details on request.

Further cable lengths on request.

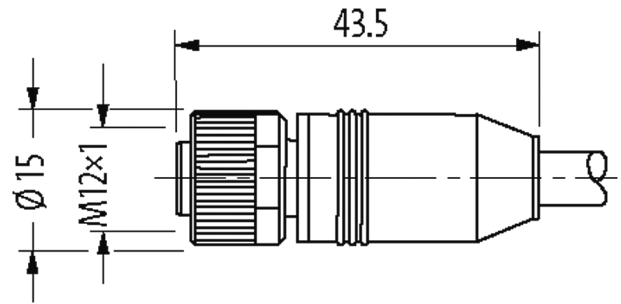
Link to Product**Illustration**

1	white
2	brown
3	green
4	yellow
5	gray
6	pink
7	blue
8	red

Female

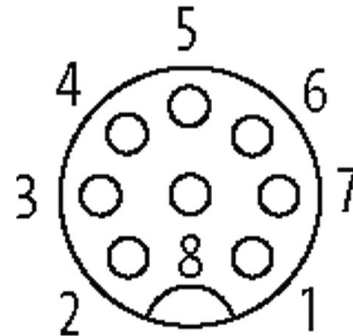

Product may differ from Image



* only for products with UL/CSA approved cable

Form

Form 17041

Technical Data

Operating voltage	max. 30 V AC/DC
Operating voltage (only UL listed)	max. 30 V AC/DC
Rated surge voltage	0.8 kV
Operating current per contact	max. 2 A
Material group	IEC 60664-1, category I

The information in this brochure has been compiled with the utmost care.

Liability for the correctness completeness and topicality of the information is restricted to gross negligence. Version: 03/22

Murrelektronik Ltd. | 5 Albion Street, Pendlebury Industrial Estate, Swinton | Manchester M27 4FG | Fon +44 161 728 3133 | Fax +44 161 728 3130 | shop@murrelektronik.co.uk | shop.murrelektronik.co.uk

Coding	A-coded
Locking of ports	Screw thread (M12×1 mm) recommended torque 0.6 Nm, self-securing
Compression gland	M12 (SW13)
Protection	IP65, IP66K, IP67 inserted and tightened (EN 60529)
Locking material	Zinc die casting, matte nickel plated
Material	PUR
suitable for corrugated tube (internal Ø)	without

General data

Standards	DIN EN 61076-2-101 (M12)
Mounting method	inserted, tightened
Pollution Degree	3
Stripping length (jacket)	60 mm
Temperature range	-25...+85 °C, depending on cable quality

Cables

Cable identification	U0H
Approval (cable)	UL (AWM-Style 20626/1731), CSA; CE conform
Cable weight [g/m]	70,40
Material (wire)	Cu wire, bare
Resistor (core)	max. 46.9 Ω/km (20 °C)
Single wire Ø (core)	0.16 mm
Construction (core)	19× 0.16 mm (multi-strand wire class 5)
Diameter (core)	1 × 8× AWG22/19 (0.382)
Material (wire isolation)	semi-rigid PVC
Wire-Ø incl. isolation	1.27m ±5%
Color/numbering of wires	br, wh, rd, bl, pk, gr, ye, gn
Stranding combination	8 wires twisted around central filler
Material (jacket)	TPE
Outer-Ø (jacket)	6.7 mm ±5%
Color (jacket)	yellow
chemical resistance	good resistance to oil, gasoline and chemicals
thermal resistance	flame retardant
Nominal voltage	300 V AC
Test voltage	2000 V AC
Current load capacity	to DIN VDE 0298-4
Temperature range (fixed)	-40...+105 °C
Temperature range (mobile)	-20...+90 °C
Bend radius (fixed)	5× outer Ø
Bend radius (moving)	10× outer Ø
No. of bending cycles (C-track)	max. 10 Mio. (25 °C)
Torsion stress	±180°/m
Jacket Color	yellow

Commercial data

country of origin	DE
customs tariff number	85444290
EAN	4048879763196
eClass	27279218
Packaging unit	1