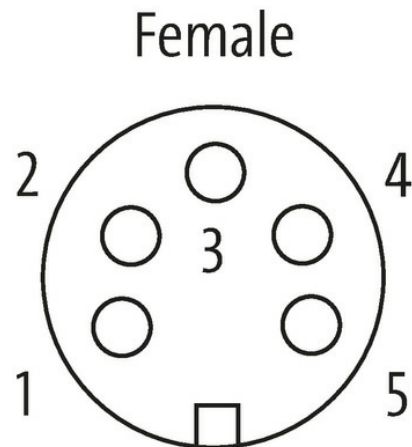
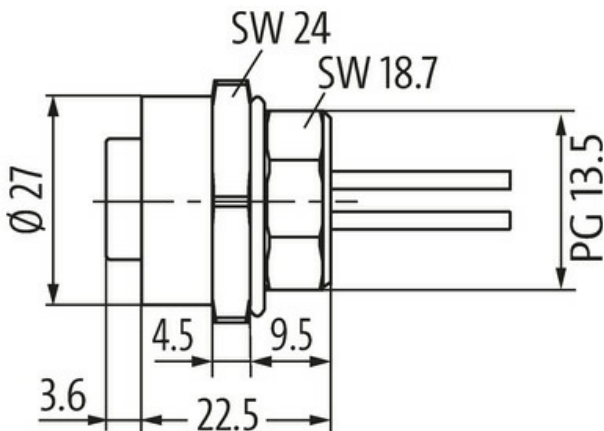
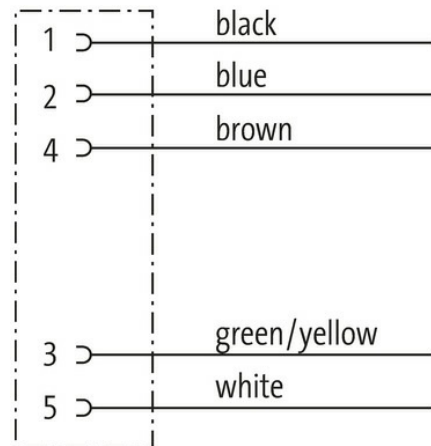

7/8" FEMALE FLANGE PLUG

Wire 5X0.75 0.2m

Flange female
7/8" (5-pole)
with multi-strand wire

[Link to Product](#)**Illustration**

Product may differ from Image

**Form**

Form 78381

Technical Data

Operating voltage	max. 300 V; max. 600 V (UL)
Rated surge voltage	4.0 kV
Operating current per contact	max. 6 A max. 8 A
Material group	IEC 60664-1, category III
Locking of ports	Screw thread 7/8" (recommended torque 1.5 Nm) self-securing

The information in this brochure has been compiled with the utmost care.
Liability for the correctness completeness and topicality of the information is restricted to gross negligence. Version: 03/22

Compression gland	7/8" (SW24)
Protection	IP68 inserted and tightened (EN 60529)
General data	
Material (contact)	Brass, gold plated
Temperature range	-25...+85 °C
Cables	
No./diameter of wires	5× 0.75 mm ²
Wire isolation	PVC (br, wh, bl, bk, gnye)
Outer Ø	3.1 mm ±5%
Cable number	978
Temperature range (fixed)	-25...+85 °C
Temperature range (mobile)	-10...+50 °C
Bend radius (fixed)	10× outer Ø
Commercial data	
country of origin	DE
customs tariff number	85444290
EAN	4048879134644
eClass	27279218
Packaging unit	1.000