

Mini (7/8) 5 pole, Male (Ext.) 90°/Female 90°

PUR 5x1.5 (5x16AWG) bk UL/CSA

Male 90° – female 90°

7/8" – 7/8", 5-pole

Power cable

USA

Further cable lengths on request.

Plastic housings with good resistance against chemicals and oils.

The resistance to aggressive media should be individually tested for your application. Further details on request.

Link to Product

Illustration

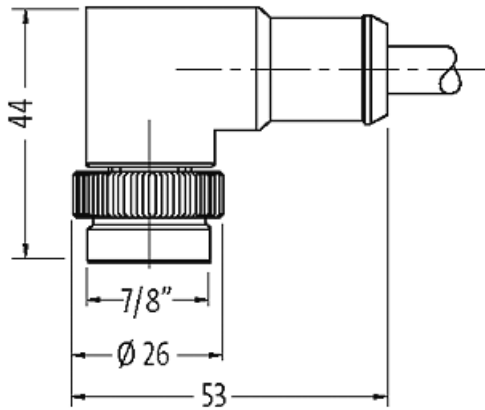
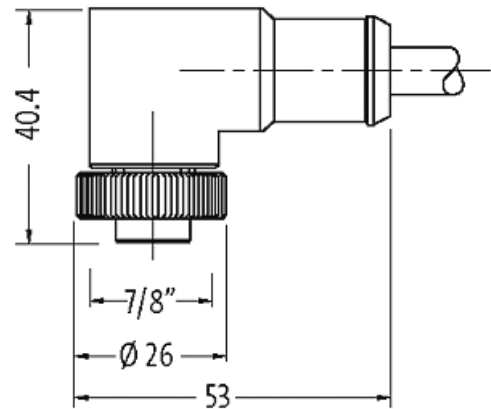

1	black	C 1
2	blue	C 2
3	green/yellow	C 3
4	brown	C 4
5	white	C 5

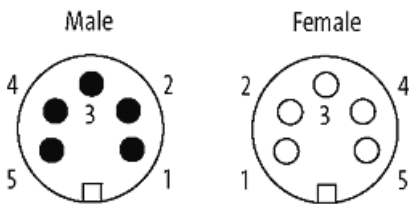

Product may differ from Image



* only for products with UL/CSA approved cable

Form	
Form	A5A31
Technical Data	
Operating voltage	max. 600 V AC/DC
Operating current per contact	max. 9 A
Locking of ports	Screw thread 7/8" (recommended torque 1.5 Nm) self-securing
Compression gland	7/8" (SW24)
Protection	IP68 inserted and tightened (EN 60529)
Locking material	Zinc die casting, matte nickel plated
Material	PUR
General data	
Temperature range	-25...+80 °C, depending on cable quality
Cables	
Cable number	UMD
No./diameter of wires	5× 1.5 mm ²
Construction (core)	2.3 mm ±5%
Wire isolation	TPM (br, wh, bl, bk, gnye)
C-track properties	5 Mio.
Jacket Color	black
Material (jacket)	PUR (UL/CSA)
Outer Ø	8.7 mm ±5%
Bend radius (fixed)	7.5× outer Ø
Bend radius (moving)	10× outer Ø
Temperature range (fixed)	-50...+80 °C
Temperature range (mobile)	-20...+80 °C
Commercial data	
country of origin	DE
customs tariff number	85444290
EAN	4048879635592
eClass	27279218
Packaging unit	1