

M12 male 90° / M12 female 0° A-cod.

TPE 8x22AWG ye UL/CSA. ITC/PLTC 0.6m

Male 90° – female straight
 M12 – M12, 8-pole
 without cable sleeves
 Cable is approved for 300 V
 USA

Plastic housings with good resistance against chemicals and oils.
 The resistance to aggressive media should be individually tested for your application. Further details on request.
 Further cable lengths on request.

[Link to Product](#)

Illustration

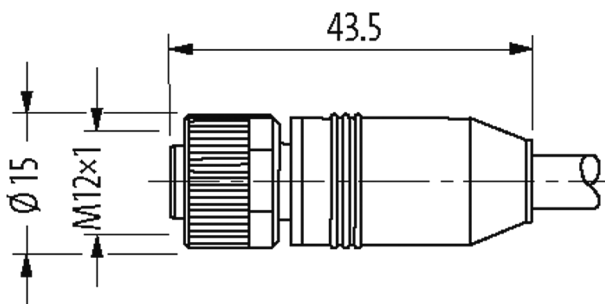
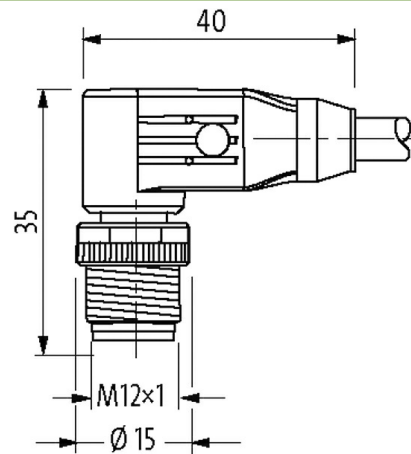
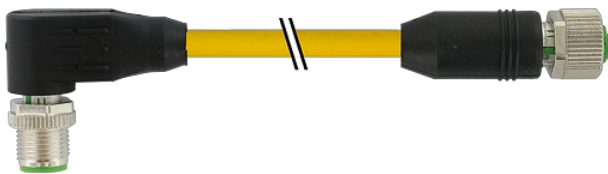

1	white	C 1
2	brown	C 2
3	green	C 3
4	yellow	C 4
5	gray	C 5
6	pink	C 6
7	blue	C 7
8	red	C 8

Male

Female

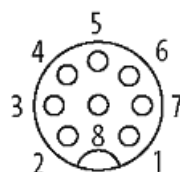
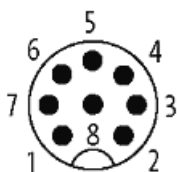

Product may differ from Image



* only for products with UL/CSA approved cable

Form	
Form	48031
Technical Data	
Operating voltage	max. 30 V AC/DC
Operating voltage (only UL listed)	max. 30 V AC/DC
Rated surge voltage	0.8 kV
Operating current per contact	max. 2 A
Material group	IEC 60664-1, category I
No. of poles	8
Coding	A-coded
LED display	no
Locking of ports	Screw thread (M12×1 mm) recommended torque 0.6 Nm, self-securing
Compression gland	M12 (SW13)
Protection	IP65, IP66K, IP67 inserted and tightened (EN 60529)
Locking material	Zinc die casting, matte nickel plated
Material	PUR
suitable for corrugated tube (internal Ø)	without
General data	
Standards	DIN EN 61076-2-101 (M12)
Mounting method	inserted, tightened
Pollution Degree	3
Temperature range	-25...+85 °C, depending on cable quality
Cables	
Cable identification	U0H
Approval (cable)	UL (AWM-Style 20626/1731), CSA; CE conform
Cable weight [g/m]	70,40
Material (wire)	Cu wire, bare
Resistor (core)	max. 46.9 Ω/km (20 °C)
Single wire Ø (core)	0.16 mm
Construction (core)	19× 0.16 mm (multi-strand wire class 5)
Diameter (core)	1 × 8× AWG22/19 (0.382)
Material (wire isolation)	semi-rigid PVC
Wire-Ø incl. isolation	1.27m ±5%
Color/numbering of wires	br, wh, rd, bl, pk, gr, ye, gn
Stranding combination	8 wires twisted around central filler
Material (jacket)	TPE
Outer-Ø (jacket)	6.7 mm ±5%
Color (jacket)	yellow
chemical resistance	good resistance to oil, gasoline and chemicals
thermal resistance	flame retardant
Nominal voltage	300 V AC
Test voltage	2000 V AC
Current load capacity	to DIN VDE 0298-4
Temperature range (fixed)	-40...+105 °C
Temperature range (mobile)	-20...+90 °C
Bend radius (fixed)	5× outer Ø
Bend radius (moving)	10× outer Ø

No. of bending cycles (C-track)	max. 10 Mio. (25 °C)
---------------------------------	----------------------

Torsion stress	±180°/m
----------------	---------

Jacket Color	yellow
--------------	--------

Commercial data

country of origin	DE
-------------------	----

customs tariff number	85444290
-----------------------	----------

EAN	4048879761345
-----	---------------

eClass	27279218
--------	----------

Packaging unit	1
----------------	---