

MET 1-PHASE CONTROL AND ISOLATION TRANSFORMER

P: 630VA IN: 230VAC+/- 5% OUT: 230VAC

Single-phase - Control and Isolation Transformers
630 VA
Spring clamp terminals
Isolation class T 60/B

[Link to Product](#)

Illustration

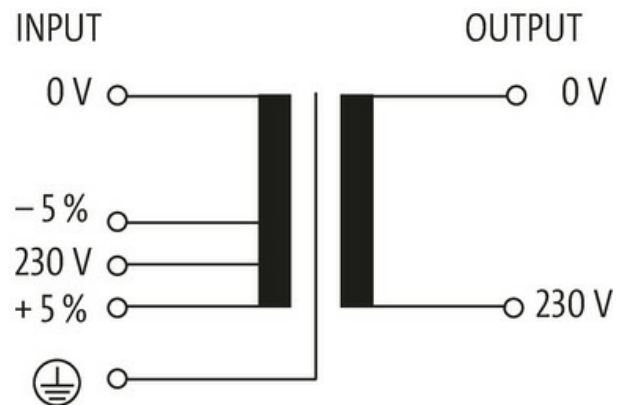

Product may differ from Image



General data

Standards	EN 61558-1, EN 61558-2-4, EN 62041 category 0
Mounting method	Key-hole mounting
Temperature range	-20...+60 °C (storage temperature -40...+80 °C)
Test isolation voltage	4 kV (prim./sec.)
Drill hole Ø	7×11 mm
Fixing centers a×b×c	107.5×122×7 mm

Dimensions H×W×D 129×150×148 mm

Output

Output voltage 230 V AC

Output rating 630 VA

Input

Input voltage 230 V AC ±5%

Inrush current 75.6 A (230 V AC)

Short-circuit current 82.3 A (230 V AC)

Input current 2.98 A (230 V AC)

Frequency 50...60 Hz

Commercial data

country of origin CZ

customs tariff number 85043180

EAN 4048879066495

eClass 27031302

Packaging unit 1.000