

**M8 male 0° A-cod. / RJ45 male 0° shielded**

PUR 1x4xAWG26 shielded gn UL/CSA+drag ch. 2.5m

Ethernet CAT5  
 Male straight – male straight  
 M8, 4-pole – RJ45, 8/4-pole  
 shielded

Further cable lengths on request.  
 Plastic housings with good resistance against chemicals and oils.  
 The resistance to aggressive media should be individually tested for your application. Further details on request.

[Link to Product](#)

Illustration

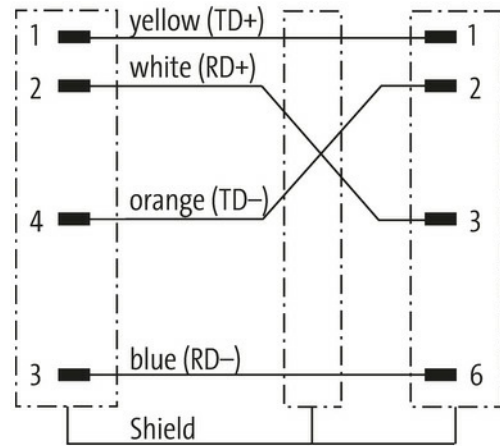

Male



Male

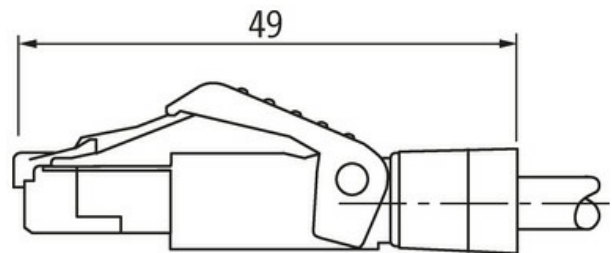

Product may differ from Image



\* only for products with UL/CSA approved cable

Form	
Form	89721
Technical Data	
Operating voltage	max. 60 V DC
Operating voltage (only UL listed)	max. 30 V DC
Rated surge voltage	1.0 kV
Operating current per contact	max. 1.5 A (20 °C)
Transfer parameters	CAT5, Class D (ISO/IEC 11801:2002), (EN 50173-1)
Material group	IEC 60664-1, category I
Locking of ports	Screw thread (M8×1 mm) recommended torque 0.4 Nm, self-securing
Compression gland	M8 (SW9)
Protection	IP67 (M8) - IP20 (RJ45)
Material	PUR
Locking material	Zinc die casting, matte nickel plated
suitable for corrugated tube (internal Ø)	6.5 mm
General data	
Standards	DIN EN 61076-2-104 (M8)
Pollution Degree	3
Temperature range	-25...+85 °C, depending on cable quality
Cables	
Cable identification	791
Approval (cable)	cURus (AWM-Style 20549/10493); CE conform
Cable weight [g/m]	59,4 g
Material (wire)	Cu wire, bare
Resistor (core)	max. 139.3 Ω/km (20 °C)
Single wire Ø (core)	0.15 mm
Construction (core)	19× 0.15 mm (multi-strand wire class 5)
Diameter (core)	1 × 4 × AWG26
AWG	similar to AWG 26
Material (wire isolation)	PO
Wire-Ø incl. isolation	1.0 mm ±5%
Color/numbering of wires	wh, or, bl, ye
Stranding combination	4 wires twisted
Shield	yes
optical shield cover	min. 85%
Material (jacket)	PUR
Material property (jacket)	CFC-, halogen-, cadmium-, silicone- and lead-free
Outer-Ø (jacket)	4.9 mm ±5%
Color (jacket)	green
chemical resistance	Oil resistance according to IEC 60811-2-1, ASTM IRM 901, ICEA S-82-552 Std.
thermal resistance	flame retardant
Temperature range (fixed)	-40...+80 °C
Temperature range (mobile)	-30...+70 °C
Bend radius (fixed)	7.5× outer Ø
Bend radius (moving)	12× outer Ø
No. of bending cycles (C-track)	max. 5 Mio. (25 °C)
Travel speed (C-track)	max. 3 m/s
Acceleration (C-track)	max. 5 m/s <sup>2</sup>

The information in this brochure has been compiled with the utmost care.

Liability for the correctness completeness and topicality of the information is restricted to gross negligence. Version: 03/22

**Commercial data**

country of origin	DE
customs tariff number	85444290
EAN	4048879724845
eClass	27061801
Packaging unit	1.000