

EXACT12, 8XM12, 4 POLE MOULDED CABLE

5.0m PUR 8x0.5+3x1.0, UL/CSA

[Link to Product](#)**Illustration**

M12-Females 4-pole

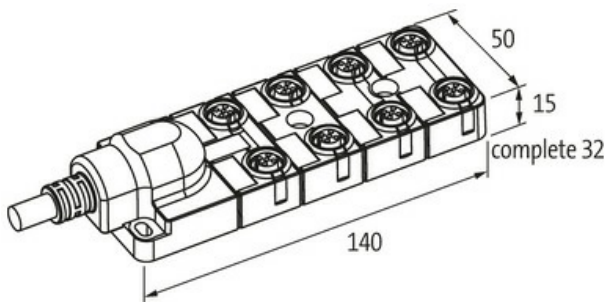
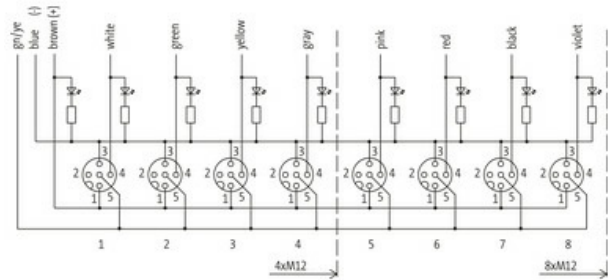
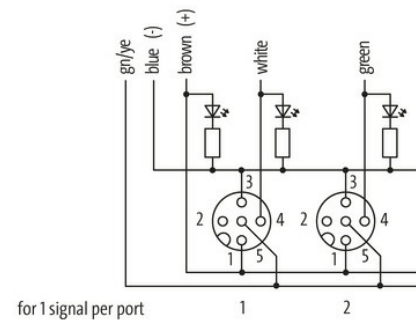
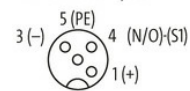

Product may differ from Image

**Technical Data**

Operating voltage	24 V DC
Operating current per contact	max. 4 A
Locking of ports	Screw thread (M12x1 mm)
Protection	IP65/IP67
Housing	Plastic, flame retardant

General data

Temperature range	-20...+70 °C, depending on cable quality
-------------------	--

Cables

No./diameter of wires	8x 0.5 + 3x 1.0 mm ²
C-track properties	5 Mio.
Outer Ø	9.4 mm ±5%
Cable number	447
Jacket Color	gray

The information in this brochure has been compiled with the utmost care. Liability for the correctness completeness and topicality of the information is restricted to gross negligence. Version: 03/22

Temperature range (fixed)	-40...+80 °C
Temperature range (mobile)	-5...+80 °C
Bend radius (fixed)	5× outer Ø
Bend radius (moving)	10× outer Ø
Material (jacket)	PUR (UL/CSA)

Contact Layout

PIN 1	(+)
PIN 3	(-)
PIN 4	(NO)/(S1)
PIN 5	(Earth)
	LED (green): Power / LED (yellow): (S1)

Commercial data

country of origin	DE
customs tariff number	85444290
EAN	4048879308960
eClass	27143423
Packaging unit	1.000