

M12 male 90° / M12 female 90° A-cod.

TPE 3x22AWG ye UL/CSA. ITC/PLTC 7.5m

Male 90° – female 90°

M12 – M12, 3-pole

USA

Plastic housings with good resistance against chemicals and oils.

The resistance to aggressive media should be individually tested for your application. Further details on request.

Further cable lengths on request.

Link to Product

Illustration

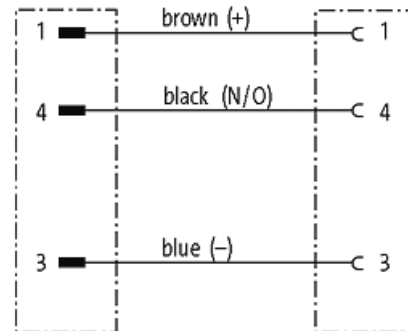
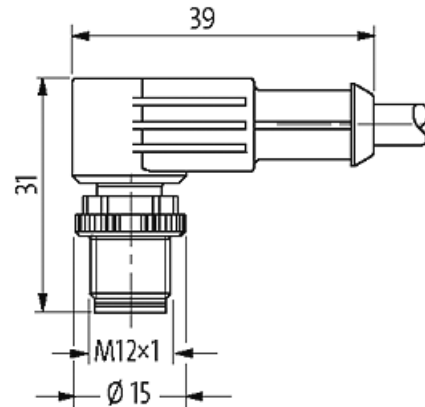
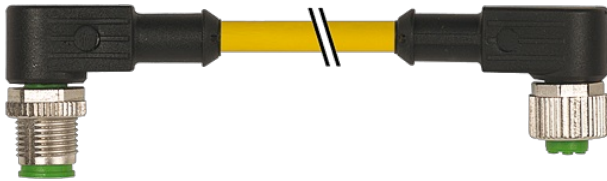

Male

Female

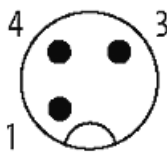

Product may differ from Image



* only for products with UL/CSA approved cable

Form	
Form	40241
Technical Data	
Operating voltage	max. 250 V AC/DC
Operating voltage (only UL listed)	max. 30 V AC/DC
Rated surge voltage	2.5 kV
Operating current per contact	max. 4 A
No. of poles	3
Material group	IEC 60664-1, category I
Coding	A-coded
LED display	no
Locking of ports	Screw thread (M12×1 mm) recommended torque 0.6 Nm, self-securing
Compression gland	M12 (SW13)
Protection	IP65, IP66K, IP67 inserted and tightened (EN 60529)
Locking material	Zinc die casting, matte nickel plated
Material	PUR
suitable for corrugated tube (internal Ø)	10 mm
General data	
Standards	DIN EN 61076-2-101 (M12)
Mounting method	inserted, tightened
Pollution Degree	3
Temperature range	-25...+85 °C, depending on cable quality
Cables	
Cable identification	U03
Approval (cable)	UL (AWM-Style 20626/1731), CSA; CE conform
Cable weight [g/m]	35,97
Material (wire)	Cu wire, bare
Resistor (core)	max. 46.9 Ω/km (20 °C)
Single wire Ø (core)	0.16 mm
Construction (core)	19× 0.16 mm (multi-strand wire class 5)
Diameter (core)	1 × 3× AWG22/19 (0.382)
Material (wire isolation)	semi-rigid PVC
Wire-Ø incl. isolation	1.27m ±5%
Color/numbering of wires	br, bk, bl
Stranding combination	3 wires twisted
Material (jacket)	TPE
Outer-Ø (jacket)	4.9 mm ±5%
Color (jacket)	yellow
chemical resistance	good resistance to oil, gasoline and chemicals
thermal resistance	flame retardant
Nominal voltage	300 V AC
Test voltage	2000 V AC
Current load capacity	to DIN VDE 0298-4
Temperature range (fixed)	-40...+105 °C
Temperature range (mobile)	-20...+90 °C
Bend radius (fixed)	5× outer Ø
Bend radius (moving)	10× outer Ø
No. of bending cycles (C-track)	max. 10 Mio. (25 °C)

The information in this brochure has been compiled with the utmost care.

Liability for the correctness completeness and topicality of the information is restricted to gross negligence. Version: 03/22

Torsion stress	±180°/m
----------------	---------

Jacket Color	yellow
--------------	--------

Commercial data

country of origin	DE
-------------------	----

customs tariff number	85444290
-----------------------	----------

EAN	4048879749381
-----	---------------

eClass	27279218
--------	----------

Packaging unit	1
----------------	---