

M8 male 90° / M8 female 90° A-cod. shielded

PVC 4x0.34 shielded gy UL/CSA 0.3m

Male 90° – female 90°

M8 – M8, 4-pole

shielded

Plastic housings with good resistance against chemicals and oils.

The resistance to aggressive media should be individually tested for your application. Further details on request.

Further cable lengths on request.

Link to Product

Illustration

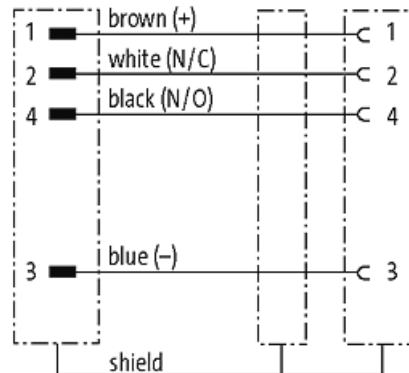
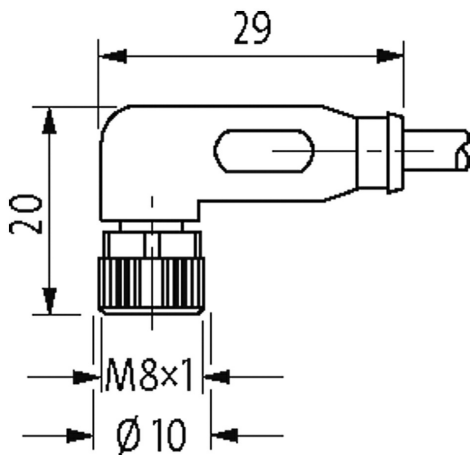
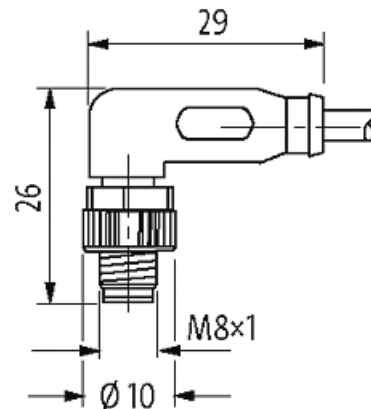

Male

Female

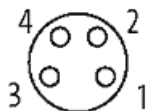

Product may differ from Image

**Form**

Form 89581

Technical Data

Operating voltage	max. 30 V AC/DC
Rated surge voltage	0.8 kV
Operating current per contact	max. 4 A
Material group	IEC 60664-1, category I
Locking of ports	Screw thread (M8×1 mm) recommended torque 0.4 Nm, self-securing
Compression gland	M8 (SW9)
Protection	IP65 and IP67 when plugged and screwed down (EN 60529)
Locking material	Zinc die casting, matte nickel plated
Material	PUR

General data

Standards	DIN EN 61076-2-104 (M8)
Pollution Degree	3
Temperature range	-25...+85 °C, depending on cable quality

Cables

No./diameter of wires	4× 0.34 mm ²
Wire isolation	PVC (br, wh, bl, bk)
Material (jacket)	PVC (UL/CSA)
Outer Ø	5.3 mm ±5%
Temperature range (fixed)	-30...+80 °C
Temperature range (mobile)	-5...+80 °C
Cable identification	201
Cable Type	1 (PVC)
Approval (cable)	UL (AWM-Style 2464/1731), CSA
Cable weight [g/m]	58,30
Material (wire)	Cu wire, bare
Resistor (core)	max. 57 Ω/km (20 °C)
Single wire Ø (core)	0.15 mm
Construction (core)	19× 0.15 mm (multi-strand wire class 5)
Diameter (core)	4× 0.34 mm ²
AWG	similar to AWG 22
Material (wire isolation)	PVC
Material property (wire isolation)	CFC-, cadmium-, silicone- and lead-free
Shore hardness (wire isolation)	45 ±5 D
Wire-Ø incl. isolation	1.25 mm ±5%
Color/numbering of wires	br, bk, bl, wh
Stranding combination	4 wires twisted
Shield	yes
Material (jacket)	PVC
Material property (jacket)	CFC-, cadmium-, silicone- and lead-free
Shore hardness (jacket)	85 ±5 A
Outer-Ø (jacket)	5.3 mm ±5%
Color (jacket)	gray
chemical resistance	good resistance to oil, gasoline and chemicals
thermal resistance	flame retardant UL 1581 VW1 / CSA FT1

Nominal voltage	300 V AC
Test voltage	2000 V AC
Current load capacity	to DIN VDE 0298-4
Temperature range (fixed)	-30...+80 °C
Temperature range (mobile)	-5...+80 °C
Bend radius (fixed)	10× outer Ø
Jacket Color	gray

Commercial data

country of origin	DE
customs tariff number	85444290
EAN	4048879409940
eClass	27279218
Packaging unit	1