

M12 male recept. A-cod. front F&B

PP-wires 8x0.25 0.2m

F&B
 Flange male
 M12, 8-pole
 Front mounting
 Stainless steel 1.4404 (V4A)

[Link to Product](#)

Illustration

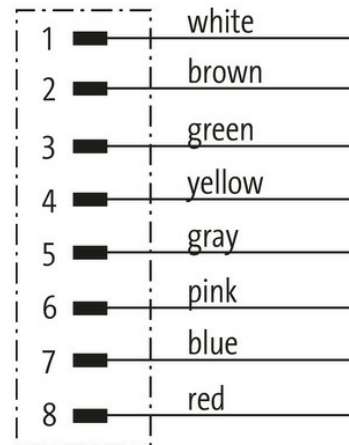

Male

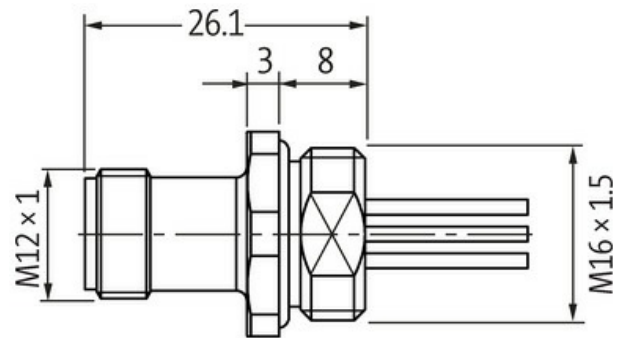
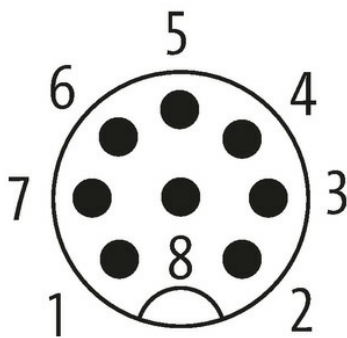

Product may differ from Image



Form

Form 17161

Technical Data

Operating voltage	max. 30 V AC/DC
Rated surge voltage	0.8 kV
Operating current per contact	max. 2 A

The information in this brochure has been compiled with the utmost care. Liability for the correctness completeness and topicality of the information is restricted to gross negligence. Version: 03/22

No. of poles	8
Material group	IEC 60664-1, category I
Coding	A-coded
LED display	no
Locking of ports	Screw thread (M12×1 mm) recommended torque 0.6 Nm, self-securing
Compression gland	M12 (SW14)
Protection	IP67 inserted and tightened (EN 60529)
Protection NEMA	3, 4, 6P (UL 50E)
Locking material	Stainless steel 1.4404 (V4A)

General data

Pollution Degree	3
Temperature range	-25...+85 °C

Cables

No./diameter of wires	8× 0.25 mm ²
Wire isolation	PUR (wh, br, gn, ye, gr, pk, bl, rd)
Outer Ø	1.25 mm ±5%
Cable number	973
Temperature range (fixed)	-40...+90 °C
Temperature range (mobile)	-25...+90 °C
Bend radius (fixed)	10× outer Ø

Commercial data

country of origin	DE
customs tariff number	85444290
EAN	4048879363594
eClass	27279220
Packaging unit	1.000