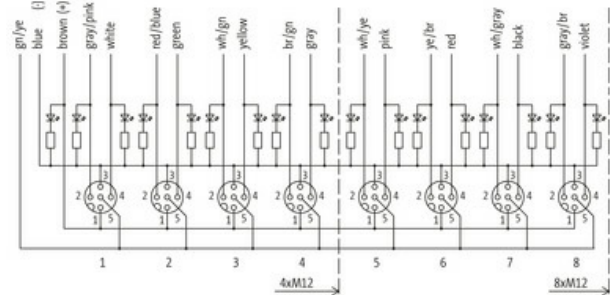
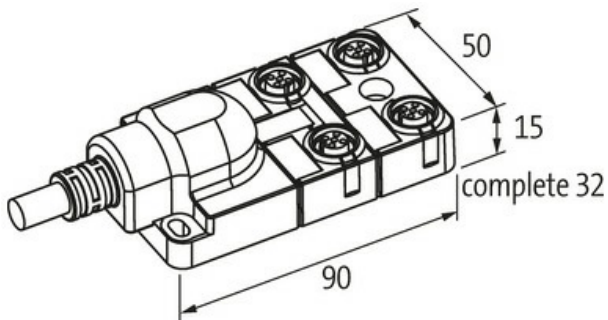

EXACT12, 4XM12, 5-POLE, MOULDED CABLE

5.0m PUR 8x0,5+3x1,0, UL/CSA

5.0 m

[Link to Product](#)**Illustration**

M12-Females 5-pole

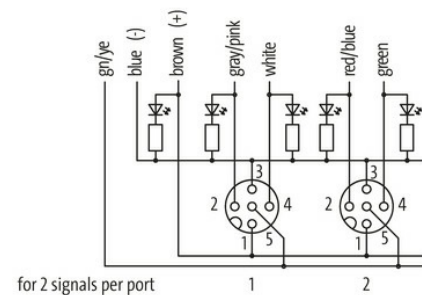
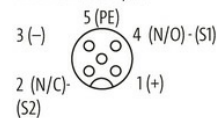

Product may differ from Image

**Technical Data**

Operating voltage	24 V DC
Operating current per contact	max. 4 A
Locking of ports	Screw thread (M12x1 mm)
Protection	IP65/IP67
Housing	Plastic, flame retardant

General data

Temperature range	-20...+70 °C, depending on cable quality
-------------------	--

Cables

No./diameter of wires	8x 0.5 + 3x 1.0 mm ²
Wire isolation	TPE (grpk, wh, rdbl, gn, whgn, ye, brgn, gr, br, bl, gnye)
C-track properties	5 Mio.
Outer Ø	9.1 mm ±5%

The information in this brochure has been compiled with the utmost care. Liability for the correctness completeness and topicality of the information is restricted to gross negligence. Version: 03/22

Cable number	448
Approval (cable)	UL (AWM-Style 20233), CSA
Material (wire)	Cu wire, bare
Construction (core)	64× 0.1 mm (0.5 mm ²), 128× 0.1 mm (1.0 mm ²); (multi-strand wire class 6)
Jacket Color	gray
Temperature range (fixed)	-40...+90 °C
Temperature range (mobile)	-40...+90 °C
Bend radius (fixed)	5× outer Ø
Bend radius (moving)	10× outer Ø
Material (jacket)	PUR (UL/CSA)

Contact Layout

PIN 1	(+)
PIN 2	(NC)/(S2)
PIN 3	(-)
PIN 4	(NO)/(S1)
PIN 5	(Earth)
LED (green): Power / LED (yellow): (S1) / LED (white): Signal (S2)	

Commercial data

country of origin	DE
customs tariff number	85444290
EAN	4048879055772
eClass	27279219
Packaging unit	1.000