

M12 female recept. B-cod. front

PP-wires 5x0.34 0.5m

Flange female

M12, 5-pole

B-coded

Front mounting

with multi-strand wire

Further cable lengths on request.

The resistance to aggressive media should be individually tested for your application. Further details on request.

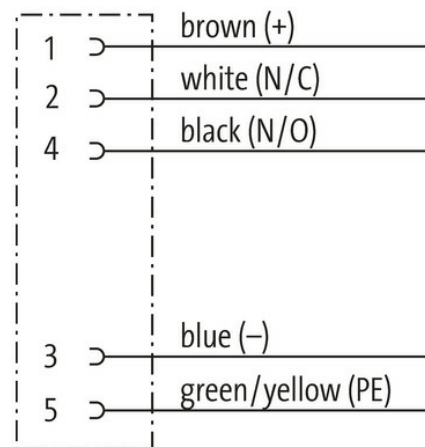
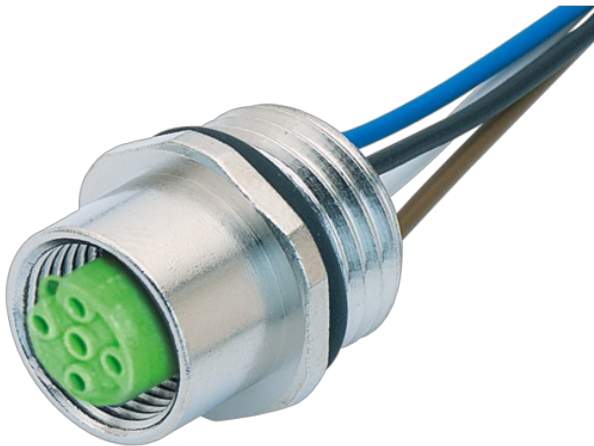
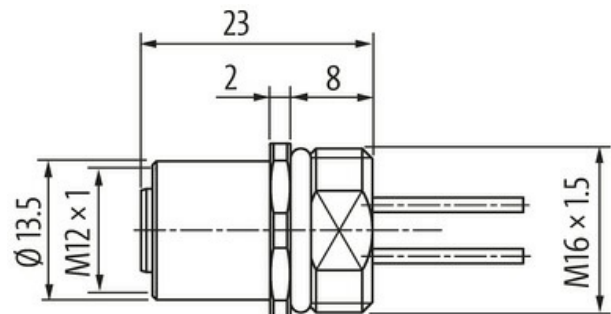
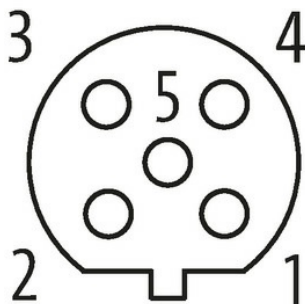
[Link to Product](#)**Illustration****Female**

Product may differ from Image

**Form**

Form 14161

Technical Data

Operating voltage max. 125 V AC/DC

Rated surge voltage	1.5 kV
Operating current per contact	max. 4 A
No. of poles	5
Material group	IEC 60664-1, category I
Coding	B-coded
LED display	no
Locking of ports	Screw thread (M12×1 mm) recommended torque 0.6 Nm, self-securing
Compression gland	M12 (SW14)
Protection	IP67 inserted and tightened (EN 60529)
Protection NEMA	3, 4, 6P (UL 50E)
Material	PUR
Locking material	Zinc die casting, matte nickel plated
suitable for corrugated tube (internal Ø)	without

General data

Standards	DIN EN 61076-2-101 (M12)
Mounting method	inserted, tightened
Material (contact)	Copper alloy
Material (contact surface)	Au
Material (gasket)	FKM
Pollution Degree	3
Temperature range	-25...+85 °C

Cables

No./diameter of wires	5× 0.34 mm ²
Wire isolation	PUR (br, wh, bl, bk, gnye)
Outer Ø	1.3 mm ±5%
Cable number	975
Material (wire)	Cu wire, tin plated
Resistor (core)	max. 58 Ω/km (20 °C)
Nominal voltage	300 V AC
Test voltage	1500 V AC
Temperature range (fixed)	-40...+90 °C
Temperature range (mobile)	-25...+90 °C
Bend radius (fixed)	5× outer Ø

Commercial data

country of origin	DE
customs tariff number	85444290
EAN	4048879371759
eClass	27279221
Packaging unit	1.000