

**M12 male 90° A-cod. / MSUD valve plug A-18mm**

PUR 5x0.34 gy UL/CSA+drag ch. 10m

**MSUD**

Form A (18 mm) – M12, male 90°

24 V DC  $\pm 25\%$ 

LED (yellow/green)

for pressure switches

Further cable lengths on request.

Plastic housings with good resistance against chemicals and oils.

The resistance to aggressive media should be individually tested for your application. Further details on request.

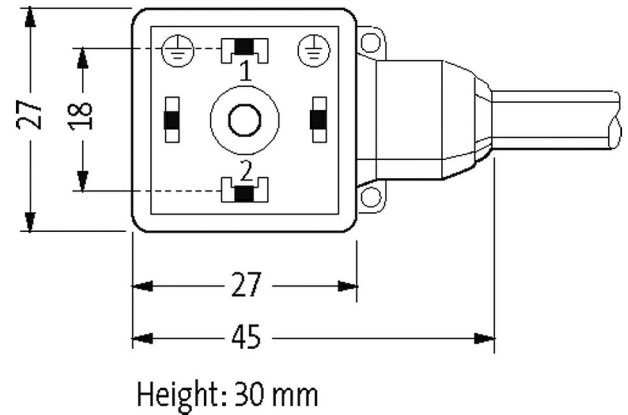
**[Link to Product](#)****Illustration**

Female

Male

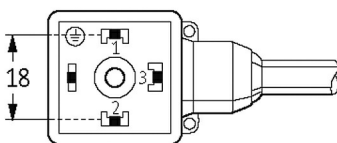

Product may differ from Image



### Technical Data

Operating voltage	24 V DC $\pm 25\%$
Operating current per contact	max. 4 A
Current consumption	approx. 12 mA
Housing	Black plastic (gray on request)
Locking of ports	M3/M12 $\times$ 1 mm (recommended torque 0.4/0.6 Nm)
Protection	IP66K, IP67 inserted and tightened (EN 60529)
Rated surge voltage	0.8 kV

### General data

Temperature range	-25...+85 °C, depending on cable quality
-------------------	--

### Cables

No./diameter of wires	5 $\times$ 0.34 mm <sup>2</sup>
Wire isolation	PP (br, wh, bl, bk, gnye)
C-track properties	10 Mio.
Material (jacket)	PUR (UL/CSA)
Outer $\varnothing$	4.8 mm $\pm 5\%$
Bend radius (moving)	10 $\times$ outer $\varnothing$
Temperature range (fixed)	-40...+80 °C
Temperature range (mobile)	-25...+80 °C
Cable identification	235
Cable Type	3 (PUR)
Approval (cable)	cURus (AWM-Style 20549/10493); CE conform
Cable weight [g/m]	41,80
Material (wire)	Cu wire, bare
Resistor (core)	max. 57 $\Omega$ /km (20 °C)
Single wire $\varnothing$ (core)	0.1 mm
Construction (core)	42 $\times$ 0.1 mm (multi-strand wire class 6)
Diameter (core)	5 $\times$ 0.34 mm <sup>2</sup>
AWG	similar to AWG 22
Material (wire isolation)	PP
Material property (wire isolation)	CFC-, halogen-, cadmium-, silicone- and lead-free
Shore hardness (wire isolation)	70 $\pm 5$ D
Wire- $\varnothing$ incl. isolation	1.25 mm $\pm 5\%$
Color/numbering of wires	br, bk, bl, wh, gnye longitudinally striped
Stranding combination	5 wires twisted around central filler
Shield	no
Material (jacket)	PUR
Material property (jacket)	CFC-, halogen-, cadmium-, silicone- and lead-free, matt, low-adhesion, machine easy to process, abrasion-resistant, hydrolysis and microbial resistant
Shore hardness (jacket)	90 $\pm 5$ A
Outer- $\varnothing$ (jacket)	4.8 mm $\pm 5\%$
Color (jacket)	gray
chemical resistance	good resistance to oil, gasoline and chemicals (EN 60811-404)
thermal resistance	flame retardand UL 1581 Section 1090 (H), CSA FT2 / IEC 60332-2-2
Nominal voltage	300 V AC
Test voltage	2500 V AC
Current load capacity	to DIN VDE 0298-4
Temperature range (fixed)	-40...+80 °C, (+90 °C at max. 10 000 operating hours)
Temperature range (mobile)	-25...+80 °C, (+90 °C at max. 10 000 operating hours)

The information in this brochure has been compiled with the utmost care.

Liability for the correctness completeness and topicality of the information is restricted to gross negligence. Version: 03/22

Bend radius (fixed)	5× outer Ø
Bend radius (moving)	10× outer Ø
No. of bending cycles (C-track)	max. 10 Mio. (25 °C)
Travel speed (C-track)	max. 3 m/s
Acceleration (C-track)	max. 10 m/s <sup>2</sup>
Torsion stress	±180°/m
No. of torsion cycles	max. 2 Mio. (25 °C)
Torsion speed	35 cycles/min
Jacket Color	gray

**Commercial data**

country of origin	CZ
customs tariff number	85444290
EAN	4048879149440
eClass	27279218
Packaging unit	1