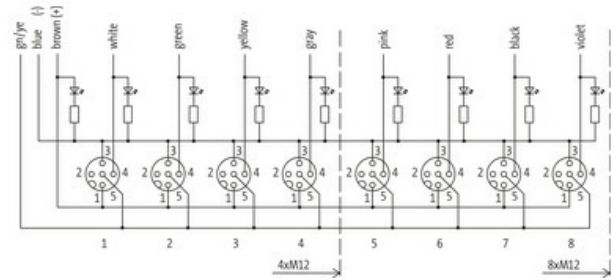
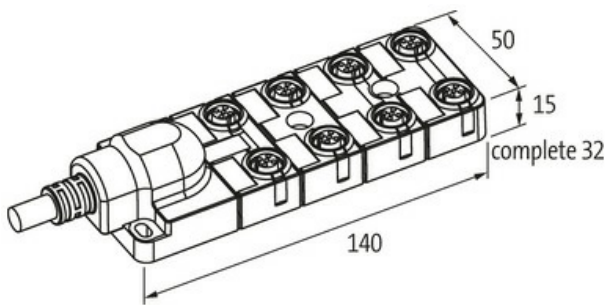

EXACT12, 8XM12, 4 POLE MOULDED CABLE

15.0m PUR/PVC 8x0,34+3X0.75, UL/CSA

PUR/PVC

15.0 m

[Link to Product](#)**Illustration**

M12-Females 4-pole

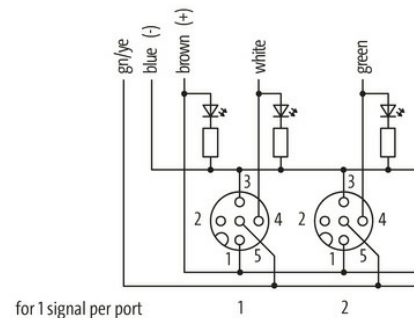
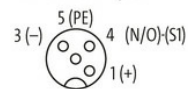

Product may differ from Image

**Technical Data**

Operating voltage	24 V DC
Operating current per contact	max. 4 A
Locking of ports	Screw thread (M12x1 mm)
Protection	IP65/IP67
Housing	Plastic, flame retardant

General data

Temperature range	-20...+70 °C, depending on cable quality
-------------------	--

Cables

No./diameter of wires	8x 0.34 + 3x 0.75 mm ²
Wire isolation	PVC
C-track properties	2 Mio.
Outer Ø	8.1 mm ±5%

Cable identification	362
Cable Type	2 (PUR/PVC)
Approval (cable)	UL (AWM-Style 20549/1731), CE conform
Cable weight [g/m]	115,5 g
Material (wire)	Cu wire, bare
Resistor (core)	max. 57 Ω/km (0.34 mm ²), max. 26 Ω/km (0.75 mm ²); (20 °C)
Single wire Ø (core)	0.15 mm (0.34 mm ²); 0.2 mm (0.75 mm ²)
Construction (core)	19× 0.15 mm (0.34 mm ²); 24× 0.2 mm (0.75 mm ²); (multi-strand wire class 5)
Diameter (core)	8× 0.34 + 3× 0.75 mm ²
AWG	similar to AWG 22 (0.34 mm ²); similar to AWG 18 (0.75 mm ²)
Material (wire isolation)	PVC
Material property (wire isolation)	CFC-, cadmium-, silicone- and lead-free
Shore hardness (wire isolation)	43 ±5 D
Wire-Ø incl. isolation	1.3 mm ±5% (0.34 mm ²); 1.8 mm ±5% (0.75 mm ²)
Color/numbering of wires	wh, vi, gn, ye, gr, pk, rd, bk+br, bl, gnye longitudinally striped
Shield	no
Material (jacket)	PUR/PVC
Outer-Ø (jacket)	8.1 mm ±5%
Color (jacket)	gray
Jacket Color	gray
chemical resistance	good resistance to oil, gasoline and chemicals (EN 60811-404)
Nominal voltage	U0/U 300/300 V AC
Test voltage	2000 V AC
Current load capacity	to DIN VDE 0298-4
Temperature range (fixed)	-30...+80 °C
Temperature range (fixed)	-30...+80 °C
Temperature range (mobile)	-5...+70 °C
Temperature range (mobile)	-5...+70 °C
Bend radius (fixed)	5× outer Ø
Bend radius (moving)	10× outer Ø
Bend radius (moving)	10× outer Ø
No. of bending cycles (C-track)	max. 2 Mio. (25 °C)
Travel speed (C-track)	max. 2 m/s
Acceleration (C-track)	max. 10 m/s ²
Material (jacket)	PUR/PVC (UL/CSA)

Contact Layout

PIN 1	(+)
PIN 3	(-)
PIN 4	(NO)/(S1)
PIN 5	(Earth)
	LED (green): Power / LED (yellow): (S1)

Commercial data

country of origin	DE
customs tariff number	85444290
EAN	4048879054249
eClass	27143423
Packaging unit	1.000