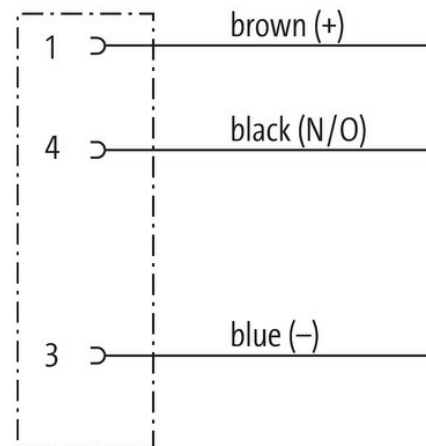

M8 female recept. A-cod. rear

PP-wires 3x0.25 0.5m

Flange female
M8, 3-pole
Rear mounting
with multi-strand wire

[Link to Product](#)**Illustration**

Female

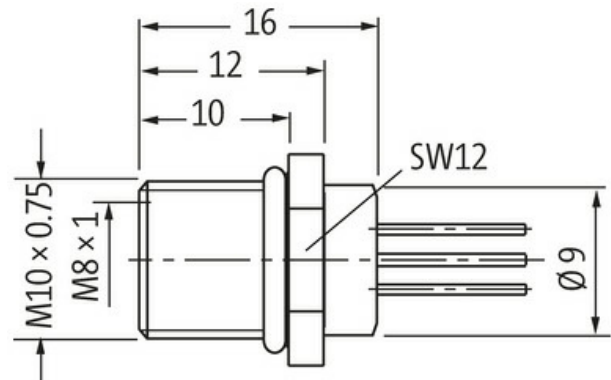
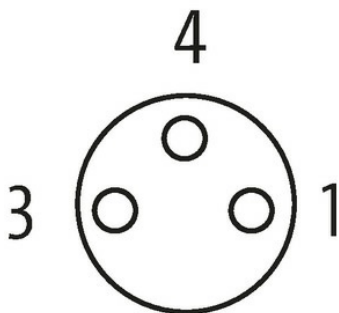

Product may differ from Image

**Form**

Form 08575

Technical Data

Operating voltage	max. 50 V AC/60 V DC
Rated surge voltage	1.5 kV
Operating current per contact	max. 4 A

No. of poles	3
Material group	IEC 60664-1, category I
LED display	no
Locking of ports	Screw thread (M8×1 mm) recommended torque 0.4 Nm, self-securing
Protection	IP67 inserted and tightened (EN 60529)
Protection NEMA	3, 4, 6P (UL 50E)

General data

Pollution Degree	3
Temperature range	-25...+85 °C

Cables

No./diameter of wires	3× 0.25 mm ²
Wire isolation	PP (br, bk, bl)
Outer Ø	1.1 mm ±5%
Cable number	970
Temperature range (fixed)	-40...+90 °C
Temperature range (mobile)	-25...+90 °C
Bend radius (fixed)	5× outer Ø

Commercial data

country of origin	DE
customs tariff number	85444290
EAN	4048879435550
eClass	27279220
Packaging unit	1.000