

M8 male 90° A-cod. / MSUD valve plug B-10mm

PVC 3x0.34 bk UL/CSA 0.6m

MSUD

Further cable lengths on request.

Form B (10 mm)

3-pole

Male M8

90°

4-pole

24 V AC $\pm 20\%$ / DC $\pm 25\%$

Z-Diode + LED

Art-No. 7005 - M8 Lite - (plastic hexagonal screw) on request

[Link to Product](#)**Illustration**

Height: 30 mm

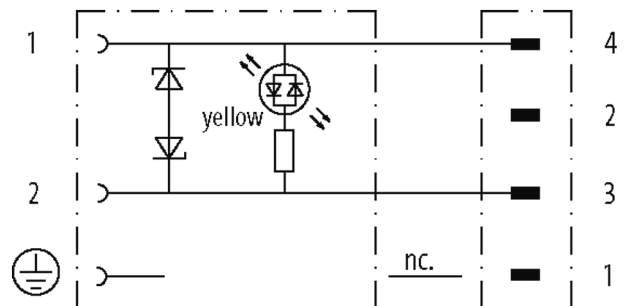
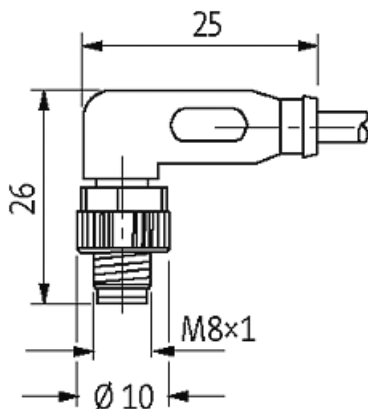

Female

Male

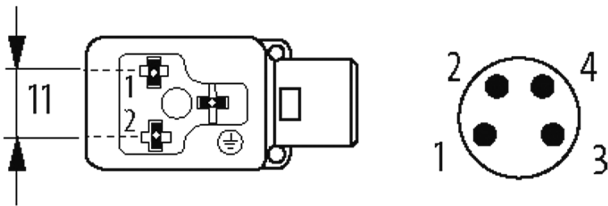

Product may differ from Image

**Form**

Form 88771

Technical Data

Operating voltage	24 V AC $\pm 20\%$ / DC $\pm 25\%$
Rated surge voltage	0.8 kV
Operating current per contact	max. 4 A
No. of poles	MSUD (3); M8 (4)
Current consumption	15 mA
Material group	IEC 60664-1, category I
Switch off peak	max. 55 V
LED display	yellow
Locking of ports	M3/M8 (recommended torque 0.4 Nm)
Compression gland	M8 (SW9)
Protection	IP65 and IP67 when plugged and screwed down (EN 60529)
Material	MSUD (PBT); M8 (PUR)
Locking material	Zinc die casting, matte nickel plated
suitable for corrugated tube (internal \varnothing)	6.5 mm
Housing	Black plastic (gray on request)
Additional suppressor	Diode/Z-Diode

General data

Standards	DIN EN 61076-2-104 (M8)
Mounting method	inserted, tightened
Material (contact)	Copper alloy
Material (contact surface)	MSUD (Ag); M8 (Au)
Material (gasket)	PUR
Pollution Degree	3
Temperature range	-25...+85 °C, depending on cable quality

Cables

No./diameter of wires	3 x 0.34 mm ²
Wire isolation	PVC (br, bl, bk)
Material (jacket)	PVC (UL/CSA)
Outer \varnothing	4.6 mm $\pm 5\%$
Bend radius (moving)	10 x outer \varnothing
Temperature range (fixed)	-30...+80 °C
Temperature range (mobile)	-5...+80 °C
Cable identification	613
Cable Type	1 (PVC)

Approval (cable)	UL (AWM-Style 2464/1731), CSA
Cable weight [g/m]	34,10
Material (wire)	Cu wire, bare
Resistor (core)	max. 60 Ω /km (20 °C)
Single wire \varnothing (core)	0.15 mm
Construction (core)	19x 0.15 mm (multi-strand wire class 5)
AWG	similar to AWG 22
Material (wire isolation)	PVC
Material property (wire isolation)	CFC-, cadmium-, silicone- and lead-free
Shore hardness (wire isolation)	45 \pm 5 D
Wire- \varnothing incl. isolation	1.25 mm \pm 5%
Color/numbering of wires	br, bk, bl
Stranding combination	3 wires twisted
Shield	no
Material (jacket)	PVC
Material property (jacket)	CFC-, cadmium-, silicone- and lead-free
Shore hardness (jacket)	85 \pm 5 A
Outer- \varnothing (jacket)	4.6 mm \pm 5%
Color (jacket)	black
chemical resistance	good resistance to oil, gasoline and chemicals
thermal resistance	flame retardant UL 1581 VW1 / CSA FT1
Nominal voltage	UL 300 V AC
Test voltage	2000 V AC
Current load capacity	to DIN VDE 0298-4
Temperature range (fixed)	-30...+80 °C
Temperature range (mobile)	-5...+80 °C
Bend radius (fixed)	5x outer \varnothing
Bend radius (moving)	10x outer \varnothing
Jacket Color	black

Commercial data

country of origin	CZ
customs tariff number	85444290
EAN	4048879116947
eClass	27279218
Packaging unit	1