

MET SINGLE-PHASE CONTROL AND ISOLATION TRANSFORMER

P:2000VA IN:400VAC±5% OUT:110VAC

Single-phase - Control and Isolation Transformers
2000 VA
Isolation class T 40/B

[Link to Product](#)

Illustration

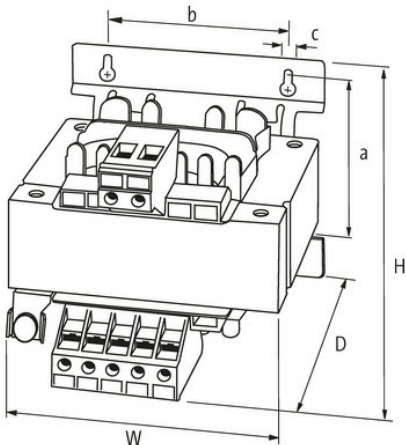
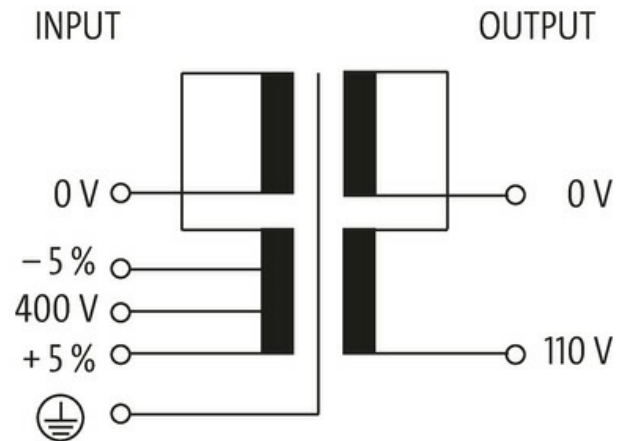

Product may differ from Image



General data

Standards	EN 61558-1, EN 61558-2-4, EN 62041 category 0
Mounting method	screw fixing
Temperature range	-20...+40 °C (storage temperature -40...+80 °C)
Test isolation voltage	5.1 kV (prim./sec.)
Drill hole Ø	9×14 mm
Fixing centers a×b×c	200×174×9 mm
Dimensions H×W×D	170×195×250 mm

The information in this brochure has been compiled with the utmost care.
Liability for the correctness completeness and topicality of the information is restricted to gross negligence. Version: 03/22

Output	
Output voltage	110 V AC
Output rating	2000 VA
Input	
Input voltage	400 V AC \pm 5%
Inrush current	94 A (400 V AC)
Short-circuit current	195 A (400 V AC)
Input current	5.3 A (400 V AC)
Frequency	50...60 Hz
Commercial data	
country of origin	CZ
customs tariff number	85043200
EAN	4048879073851
eClass	27031202
Packaging unit	1.000