

M12 male 0° / M12 female 0° A-cod.

PUR (4x0.5C+2x0.5)C shielded ye 5m

Cube67

Male straight – female straight

M12 – M12, 6-pole

shielded

Hybrid cable

Plastic housings with good resistance against chemicals and oils.

The resistance to aggressive media should be individually tested for your application. Further details on request.

Further cable lengths on request.

Link to Product

Illustration

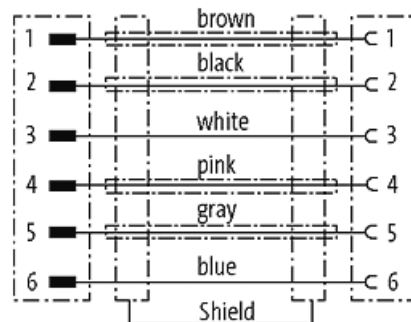
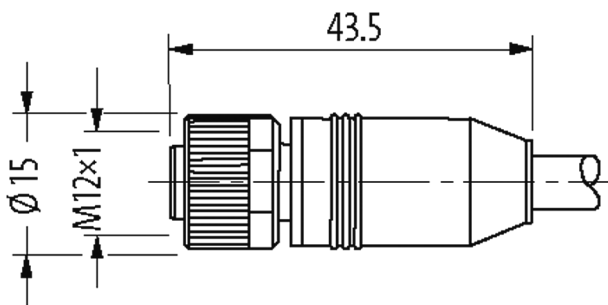

Male

Female

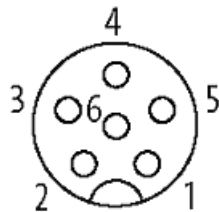
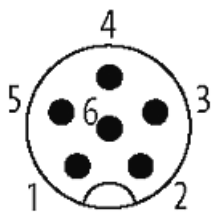

Product may differ from Image



* only for products with UL/CSA approved cable

Form

Form

46045

Technical Data	
Operating voltage	max. 30 V AC/DC
Operating current per contact	max. 4 A
Locking of ports	Screw thread (M12×1 mm) recommended torque 0.6 Nm, self-securing
Protection	IP66K, IP67 inserted and tightened (EN 60529)
Rated surge voltage	1.5 kV
Cables	
Cable number	138
No./diameter of wires	4× 0.5 + 2× 0.5 mm ²
Wire isolation	PP (br, wh, bl, bk, gr, pk)
C-track properties	5 Mio.
Jacket Color	yellow
Material (jacket)	PUR
Outer Ø	8.0 mm ±5%
Bend radius (moving)	10× outer Ø
Temperature range (fixed)	-40...+80 °C
Temperature range (mobile)	-5...+80 °C
Cable identification	138
Approval (cable)	CE conform
Cable weight [g/m]	123,20
Material (wire)	Cu wire, bare
Resistor (core)	max. 39 Ω/km (20 °C)
Single wire Ø (core)	0.15 mm
Construction (core)	28× 0.15 mm (multi-strand wire class 6)
Diameter (core)	4× 0.5 + 2× 0.5 mm ²
AWG	similar to AWG 20
Material (wire isolation)	PP
Material property (wire isolation)	CFC-, halogen-, cadmium-, silicone- and lead-free
Shore hardness (wire isolation)	55 ±5 D
Wire-Ø incl. isolation	1.5 mm ±5%
Color/numbering of wires	br, bl, gr, pk, wh, bk
Shield	yes
optical shield cover	min. 85%
Material (jacket)	PUR
Shore hardness (jacket)	85 ±5 A
Outer-Ø (jacket)	8.0 mm ±5%
Color (jacket)	yellow
chemical resistance	good resistance to oil, gasoline and chemicals (VDE 0472 Teil 803 Test B)
Nominal voltage	100 V AC
Test voltage	1200 V AC
Temperature range (fixed)	-40...+80 °C
Temperature range (mobile)	-5...+80 °C
Bend radius (moving)	10× outer Ø
No. of bending cycles (C-track)	max. 5 Mio. (25 °C)
Traversing distance (C-track)	max. 5 m (horizontal)
Travel speed (C-track)	max. 3.3 m/s
Acceleration (C-track)	max. 5 m/s ²
Commercial data	
country of origin	DE
customs tariff number	85444290
EAN	4048879140225
eClass	27061801
Packaging unit	1

