

**Y-Distributor M12 male / M12 female 90° A-cod. LED**

PUR 3x0.34 bk UL/CSA+robot+drag ch. 0.6m

Y-connector M12 – M12, 4-pole  
 Zinc die casting, save-cover coated  
 Male straight – females 90°  
 A-coded  
 bridged

LED (yellow/green)

Art-No. 7005 - M12 Lite - (plastic hexagonal screw) on request

Plastic housings with good resistance against chemicals and oils.

The resistance to aggressive media should be individually tested for your application. Further details on request.

Further cable lengths on request.

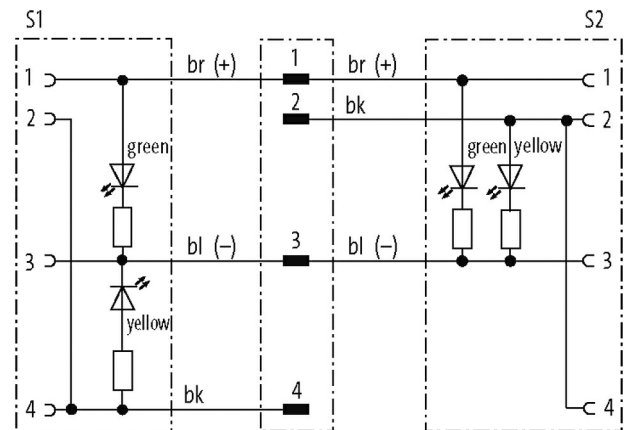
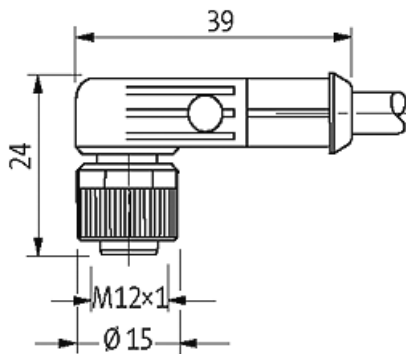
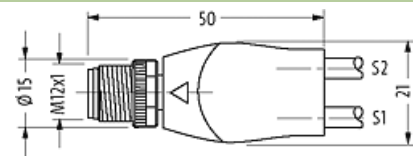
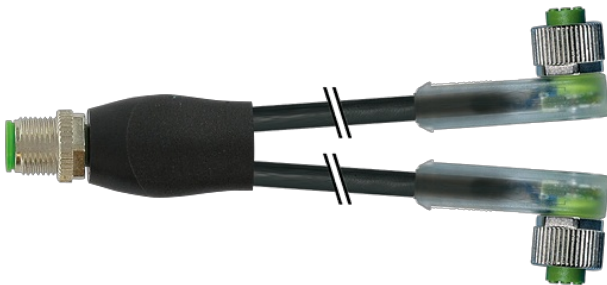
**Link to Product****Illustration**



Product may differ from Image

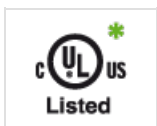

\* only for products with UL/CSA approved cable

Form	
Form	40801
Technical Data	
Operating voltage	24 V DC $\pm 25\%$
Operating voltage (only UL listed)	30 V DC
Rated surge voltage	0.8 kV
Operating current per contact	max. 4 A
No. of poles	4
Current consumption	5 mA
Material group	IEC 60664-1, category I
Coding	A-coded
LED display	LED (yellow/green)
Locking of ports	Screw thread (M12 $\times$ 1 mm) recommended torque 0.6 Nm, self-securing
Compression gland	M12 (SW13)
Protection	IP65, IP66K, IP67 inserted and tightened (EN 60529)
Material	PUR
suitable for corrugated tube (internal $\varnothing$ )	10 mm
Locking material	Zinc die casting, save-cover coated
General data	
Standards	DIN EN 61076-2-101 (M12)
Mounting method	inserted, tightened
Material (contact)	Copper alloy
Material (contact surface)	Au
Material (gasket)	FKM
Pollution Degree	3
Temperature range	-25...+85 °C, depending on cable quality
Cables	
No./diameter of wires	3 $\times$ 0.34 mm <sup>2</sup>
Wire isolation	PP (br, bl, bk)
C-track properties	10 Mio.
Material (jacket)	PUR (UL/CSA), welding spark
Outer $\varnothing$	4.3 mm $\pm 5\%$
Bend radius (moving)	10 $\times$ outer $\varnothing$
Temperature range (fixed)	-40...+80 °C
Temperature range (mobile)	-25...+80 °C

The information in this brochure has been compiled with the utmost care.

Liability for the correctness completeness and topicality of the information is restricted to gross negligence. Version: 03/22

Murrelektronik Ltd. | 5 Albion Street, Pendlebury Industrial Estate, Swinton | Manchester M27 4FG | Fon +44 161 728 3133 | Fax +44 161 728 3130 | shop@murrelektronik.co.uk | shop.murrelektronik.co.uk

Cable identification	653
Cable Type	5 (PUR schweißfunkenbeständig)
Approval (cable)	cURus (AWM-Style 20549/10493); CE conform
Cable weight [g/m]	29,70
Material (wire)	Cu wire, bare
Resistor (core)	max. 60 $\Omega$ /km (20 °C)
Single wire $\varnothing$ (core)	0.1 mm
Construction (core)	42x 0.1 mm (multi-strand wire class 6)
Diameter (core)	3x 0.34 mm <sup>2</sup>
AWG	similar to AWG 22
Material (wire isolation)	PP
Material property (wire isolation)	CFC-, halogen-, cadmium-, silicone- and lead-free
Shore hardness (wire isolation)	74 $\pm$ 3 D
Wire- $\varnothing$ incl. isolation	1.25 mm $\pm$ 5%
Color/numbering of wires	br, bk, bl
Stranding combination	3 wires twisted
Shield	no
Material (jacket)	PUR
Material property (jacket)	CFC-, halogen-, cadmium-, silicone- and lead-free, matt, low-adhesion, machine easy to process, abrasion-resistant, hydrolysis-, microbial- and welding spark resistant
Shore hardness (jacket)	58 $\pm$ 3 D
Outer- $\varnothing$ (jacket)	4.3 mm $\pm$ 5%
Color (jacket)	black
chemical resistance	good resistance to oil, gasoline and chemicals (EN 60811-404)
thermal resistance	flame retardant UL, FT2, IEC 60332-1, IEC 60332-2-2, welding spark resistant
Nominal voltage	300 V AC
Test voltage	2500 V AC
Current load capacity	to DIN VDE 0298-4
Temperature range (fixed)	-40...+80 °C, (+90 °C at max. 10 000 operating hours)
Temperature range (mobile)	-25...+80 °C, (+90 °C at max. 10 000 operating hours)
Bend radius (fixed)	5x outer $\varnothing$
Bend radius (moving)	10x outer $\varnothing$
No. of bending cycles (C-track)	max. 10 Mio. (25 °C)
Traversing distance (C-track)	max. 5 m (horizontal)
Travel speed (C-track)	max. 3.3 m/s
Acceleration (C-track)	max. 5 m/s <sup>2</sup>
Torsion stress	$\pm$ 360°/m
No. of torsion cycles	max. 1 Mio. (25 °C)
Torsion speed	35 cycles/min
Jacket Color	black

#### Commercial data

country of origin	DE
customs tariff number	85444290
EAN	4048879154918
eClass	27279218
Packaging unit	1