

## Valve plug MJC 90° with cable LED

PUR 2x0.75 bk 3m

Female 90°

10...30 V AC/DC

LED

Plastic housings with good resistance against chemicals and oils.

The resistance to aggressive media should be individually tested for your application. Further details on request.

Further cable lengths on request.

### Link to Product

#### Illustration

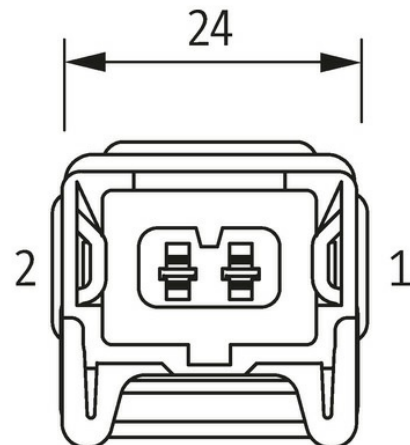
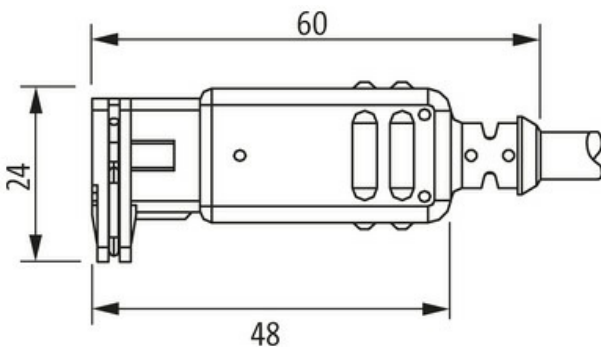
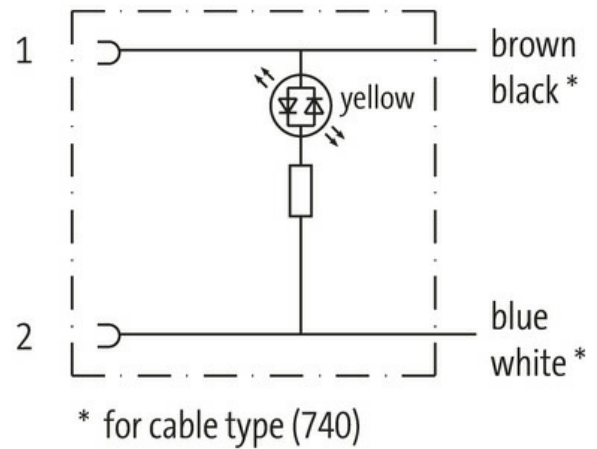

Product may differ from Image

#### Form

Form 70321

#### Technical Data

Operating voltage	10...30 V AC/DC
Rated surge voltage	0.8 kV
Operating current per contact	max. 4 A
Current consumption	approx. 12 mA
LED display	(yellow)
Protection	IP65 inserted and tightened (EN 60529)
Housing	Black plastic, flame retardant

The information in this brochure has been compiled with the utmost care.

Liability for the correctness completeness and topicality of the information is restricted to gross negligence. Version: 03/22

Murrelektronik Ltd. | 5 Albion Street, Pendlebury Industrial Estate, Swinton | Manchester M27 4FG | Fon +44 161 728 3133 | Fax +44 161 728 3130 | shop@murrelektronik.co.uk | shop.murrelektronik.co.uk

**General data**

Temperature range	-25...+85 °C, depending on cable quality
-------------------	--

**Cables**

No./diameter of wires	2× 0.75 mm <sup>2</sup>
Wire isolation	PVC (br, bl)
Outer Ø	5.9 mm ±5%
Cable identification	750
Cable number	750
Approval (cable)	CE conform
Cable weight [g/m]	48,4 g
Material (wire)	Cu wire, bare
Resistor (core)	max. 26 Ω/km (20 °C)
Single wire Ø (core)	0.2 mm
Construction (core)	24× 0.2 mm (multi-strand wire class 5)
Diameter (core)	2× 0.75 mm <sup>2</sup>
AWG	similar to AWG 18
Material (wire isolation)	PVC
Color/numbering of wires	br, bl
Stranding combination	2 wires twisted
Shield	no
Material (jacket)	PUR/PVC
Outer-Ø (jacket)	5.9 mm ±5%
Color (jacket)	black
Jacket Color	black
chemical resistance	good resistance to oil, gasoline and chemicals
Nominal voltage	300 V AC
Test voltage	2000 V AC
Temperature range (fixed)	-40...+80 °C
Temperature range (fixed)	-40...+80 °C
Temperature range (mobile)	-5...+80 °C
Temperature range (mobile)	-5...+80 °C
Bend radius (moving)	15× outer Ø
Bend radius (moving)	15× outer Ø
Material (jacket)	PUR/PVC

**Commercial data**

country of origin	DE
customs tariff number	85444290
EAN	4048879286152
eClass	27279218
Packaging unit	1.000