

**M12 Xtreme male 0° A-cod. / MSUD valve plug A-18mm**

PUR 2x0.75 bk UL/CSA+drag ch. 0.3m

Xtreme - Outdoor  
Stainless steel 1.4305 (V2A)  
MSUD  
Form A (18 mm)  
4-pole  
Male M12  
straight  
2-pole  
12...24 V AC/DC  
Z-Diode + LED

[Link to Product](#)

**Illustration**

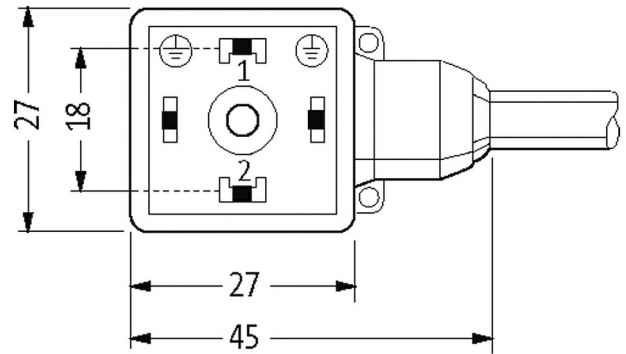

Height: 30 mm

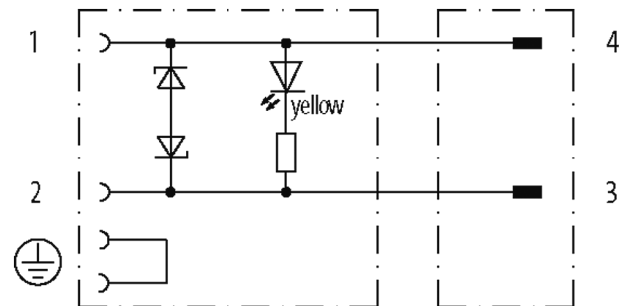
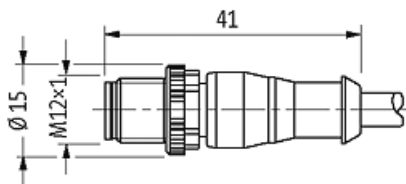

Female

Male

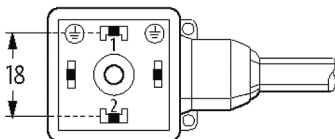

Product may differ from Image



Form	
Form	40881
Technical Data	
Operating voltage	12...24 V AC/DC
Rated surge voltage	0.8 kV
Operating current per contact	max. 4 A
No. of poles	MSUD (4); M12 (2)
Current consumption	8 mA
Material group	IEC 60664-1, category I
Switch off peak	max. 55 V
Coding	A-coded
LED display	yellow
Locking of ports	M3/M12×1 mm (recommended torque 0.4/0.6 Nm)
Compression gland	M12 (SW14)
Protection	IP65, IP66K, IP67, IP68 inserted and tightened (EN 60529)
Material	MSUD (PBT); M12 (PUR)
Locking material	Stainless steel 1.4305 (V2A)
suitable for corrugated tube (internal Ø)	10 mm
Housing	Black plastic (gray on request)
Additional suppressor	Diode/Z-Diode
General data	
Standards	DIN EN 61076-2-101 (M12)
Mounting method	inserted, tightened
Material (contact)	Copper alloy
Material (contact surface)	MSUD (Ag); M12(Au)
Material (gasket)	Silicon
Cables	
No./diameter of wires	2× 0.75 mm <sup>2</sup>
Wire isolation	PP (br, bl)
C-track properties	10 Mio.
Material (jacket)	PUR (UL/CSA)
Outer Ø	5.0 mm ±5%
Bend radius (moving)	10× outer Ø
Temperature range (fixed)	-40...+80 °C
Temperature range (mobile)	-25...+80 °C
Cable identification	754
Cable Type	3 (PUR)
Approval (cable)	cURus (AWM-Style 20549/10493); CE conform
Cable weight [g/m]	40,70
Material (wire)	Cu wire, bare
Resistor (core)	max. 26 Ω/km (20 °C)
Single wire Ø (core)	0.15 mm
Construction (core)	42× 0.15 mm (multi-strand wire class 6)
Diameter (core)	2× 0.75 mm <sup>2</sup>
AWG	similar to AWG 18
Material (wire isolation)	PP
Material property (wire isolation)	CFC-, halogen-, cadmium-, silicone- and lead-free
Shore hardness (wire isolation)	70 ±5 D
Wire-Ø incl. isolation	1.7 mm ±5%
Color/numbering of wires	br, bl
Stranding combination	2 wires twisted
Shield	no

Material (jacket)	PUR
Material property (jacket)	CFC-, halogen-, cadmium-, silicone- and lead-free, matt, low-adhesion, machine easy to process, abrasion-resistant, hydrolysis and microbial resistant
Shore hardness (jacket)	90 ±5 A
Outer-Ø (jacket)	5.0 mm ±5%
Color (jacket)	black
chemical resistance	good resistance to oil, gasoline and chemicals (EN 60811-404)
thermal resistance	flame retardand UL 1581 Section 1090 (H), CSA FT2 / IEC 60332-2-2
Nominal voltage	300 V AC
Test voltage	2500 V AC
Current load capacity	to DIN VDE 0298-4
Temperature range (fixed)	-40...+80 °C, (+90 °C at max. 10 000 operating hours)
Temperature range (mobile)	-25...+80 °C, (+90 °C at max. 10 000 operating hours)
Bend radius (fixed)	5× outer Ø
Bend radius (moving)	10× outer Ø
No. of bending cycles (C-track)	max. 10 Mio. (25 °C)
Travel speed (C-track)	max. 3 m/s
Acceleration (C-track)	max. 10 m/s <sup>2</sup>
Torsion stress	±180°/m
No. of torsion cycles	max. 2 Mio. (25 °C)
Torsion speed	35 cycles/min
Jacket Color	black

#### Commercial data

country of origin	CZ
customs tariff number	85444290
EAN	4048879309226
eClass	27279218
Packaging unit	1