

M8 male 90° with cable, 180°

PUR 8x0.14 bk 3m

Male 90°

M8, 8-pole

with cable sleeves

Attention: Contact carrier turned to 180°!

Plastic housings with good resistance against chemicals and oils.

The resistance to aggressive media should be individually tested for your application. Further details on request.

Further cable lengths on request.

[Link to Product](#)

Illustration

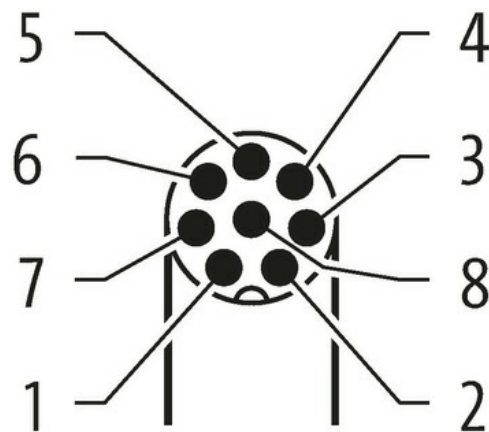
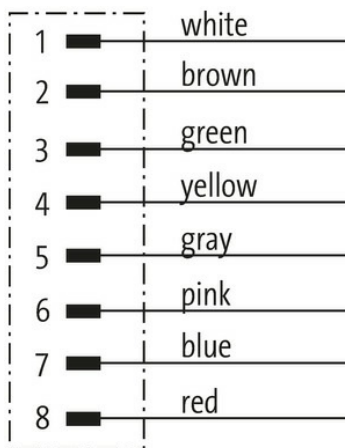
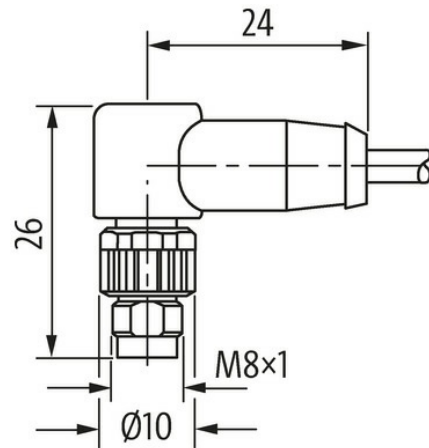
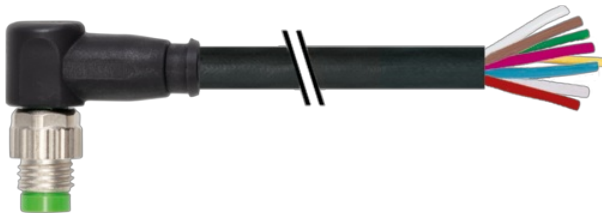

Product may differ from Image



Form

Form 08932

Technical Data

Operating voltage	max. 30 V AC/DC
Operating current per contact	max. 1.5 A
No. of poles	8
Mating cycles	≥ 100
LED display	no
Locking of ports	Screw thread (M8×1 mm) recommended torque 0.4 Nm, self-securing
Compression gland	M8 (SW9)
Protection	IP67 inserted and tightened (EN 60529)
Material	TPU
Locking material	Zinc die casting, matte nickel plated

General data

Mounting method	inserted, tightened
Material (contact)	Copper alloy
Material (contact surface)	Au
Pollution Degree	3/2
Temperature range	-25...+80 °C

Cables

Cable identification	696
Material (wire)	Cu wire, bare
Resistor (core)	max. 78 Ω/km (20 °C)
Single wire Ø (core)	0.1 mm
Construction (core)	18× 0.1 mm (multi-strand wire class 6)
Diameter (core)	8× 0.14 mm ²
AWG	similar to AWG 14
Material (wire isolation)	PP
Wire-Ø incl. isolation	1.07 mm ±5%
Stranding combination	8 wires twisted around central filler
Shield	no
Material (jacket)	PUR
Outer-Ø (jacket)	5.5 mm ±5%
Color (jacket)	black
Jacket Color	black
Nominal voltage	300 V
Test voltage	3000 V AC
Temperature range (fixed)	-30...+80 °C
Temperature range (mobile)	-15...+80 °C
Bend radius (fixed)	6× outer Ø
No. of bending cycles (C-track)	max. 2 Mio. (25 °C)
Travel speed (C-track)	max. 5 m/s
Acceleration (C-track)	max. 10 m/s ²

Commercial data

country of origin	DE
customs tariff number	85444290
EAN	4048879783378
eClass	27279218
Packaging unit	1.000