

ACCESSORY FOR VL400UL, VL400XUL MOTOR DRIVE WITH STORAGE SPRING 220...250V AC/DC

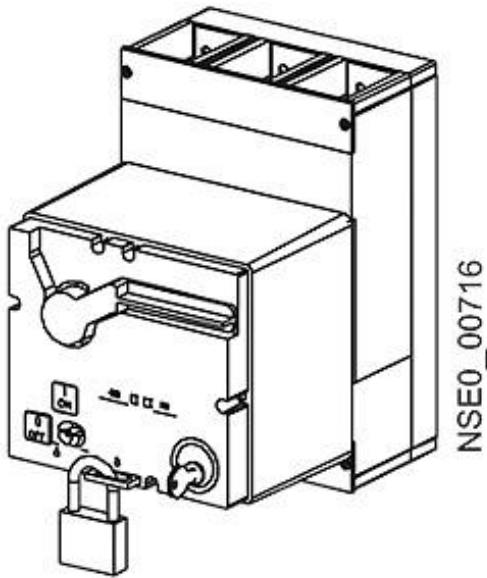









Figure similar

Model	
product brandname	SETRON
Accessories	
accessories	Accessories for...UL, VL400002

General Product Approval	EMC	Test Certificates	Shipping Approval
sonstig  UL	 EAC	 C-Tick	spezielle Prüfbescheinigungen n  BUREAU VERITAS

Shipping Approval	other
 PRS	 RINA
 RMRS	Umweltbestätigung
	sonstig
	Bestätigungen

Further information

Information- and Downloadcenter (Catalogs, Brochures,...)

<http://www.siemens.com/lowvoltage/catalogs>

Industry Mall (Online ordering system)

<https://eb.automation.siemens.com/mall/en/WW/Catalog/Product/3VL9400-3MQ01>

Service&Support (Manuals, Certificates, Characteristics, FAQs,...)

<http://support.automation.siemens.com/WW/view/en/3VL9400-3MQ01/all>

Image database (product images, 2D dimension drawings, 3D models, device circuit diagrams, ...)

http://www.automation.siemens.com/bilddb/cax_en.aspx?mlfb=3VL9400-3MQ01

CAX-Online-Generator

<http://www.siemens.com/cax>

Tender specifications

<http://www.siemens.com/specifications>