

ACCESSORY FOR VL630, VL800, STORED ENERGY OPERATOR  
110...127V AC/DC WITH AUXILIARY SWITCH

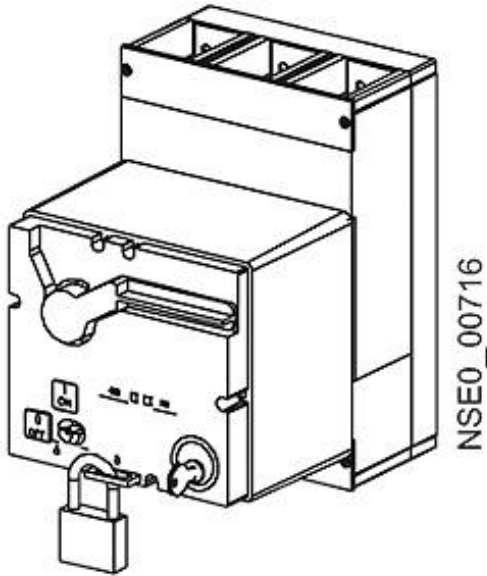









Figure similar

Model	
product brandname	SENTRON
Accessories	
accessories	Accessories for VL630, VL800

General Product Approval	EMC	Declaration of Conformity	Test Certificates	Shipping Approval
<a href="#">sonstig</a> 	 C-Tick	 EG-Konf.	<a href="#">spezielle Prüfbescheinigungen</a> <a href="#">n</a>	

Shipping Approval	other
 PRS	 RINA
 RMRS	<a href="#">sonstig</a>
	<a href="#">Bestätigungen</a>
	<a href="#">Umweltbestätigung</a>

### Further information

#### Information- and Downloadcenter (Catalogs, Brochures,...)

<http://www.siemens.com/lowvoltage/catalogs>

#### Industry Mall (Online ordering system)

<https://eb.automation.siemens.com/mall/en/WW/Catalog/Product/3VL9600-3MK00>

#### Service&Support (Manuals, Certificates, Characteristics, FAQs,...)

<http://support.automation.siemens.com/WW/view/en/3VL9600-3MK00/all>

#### Image database (product images, 2D dimension drawings, 3D models, device circuit diagrams, ...)

[http://www.automation.siemens.com/bilddb/cax\\_en.aspx?mlfb=3VL9600-3MK00](http://www.automation.siemens.com/bilddb/cax_en.aspx?mlfb=3VL9600-3MK00)

#### CAX-Online-Generator

<http://www.siemens.com/cax>

#### Tender specifications

<http://www.siemens.com/specifications>