

SITOR fuse size 3 630A aR 900V dc/1250V VSI 1000V dc UL @MBC 8xIn screw connection M12 73mm flat contacts



Model	
product brand name	SETRON
product designation	SITOR fuse link
design of the product	With female thread on both sides
design of an identification indicator	with front indicator
design of the switching contact	M12 73mm flat contacts
design of the fuse link	SITOR, LV HRC design
General technical data	
size of fuse system according to EN 60269-1	NH3
operating class of the fuse link	aR
type of voltage of the operating voltage	DC
Supply voltage	
supply voltage	
• at DC	900 V
Breaking Capacity	
switching capacity current	
• at DC according to IEC 60947-2 rated value	100 kA
• according to IEC 60947-2 rated value	100 kA
Dissipation	
power loss [W]	120 W
power loss [W]	
• for rated value of the current at AC in hot operating state per pole	120 W
• maximum	120 W
Product details	
product description	with female thread on both sides, silver-plated
accessories included	no
Mechanical Design	
mounting position	Any, preferably vertical
net weight	1 003 g
Environmental conditions	
ambient temperature during operation	
• minimum	-20 °C
• maximum	50 °C
environmental category	-20 to +50 at 95% relative humidity
Approvals Certificates	
General Product Approval	other



[Confirmation](#)



[Miscellaneous](#)

[Confirmation](#)

Environment



[Environmental Confirmations](#)

Further information

Information on the packaging

<https://support.industry.siemens.com/cs/ww/en/view/109813875>

Information- and Downloadcenter (Catalogs, Brochures,...)

<http://www.siemens.com/lowvoltage/catalogs>

Industry Mall (Online ordering system)

<https://mall.industry.siemens.com/mall/en/en/Catalog/product?mlfb=3NB1342-3KK12>

Service&Support (Manuals, Certificates, Characteristics, FAQs,...)

<https://support.industry.siemens.com/cs/ww/en/ps/3NB1342-3KK12>

Image database (product images, 2D dimension drawings, 3D models, device circuit diagrams, ...)

http://www.automation.siemens.com/bilddb/cax_en.aspx?mlfb=3NB1342-3KK12

CAX-Online-Generator

<http://www.siemens.com/cax>

Tender specifications

<http://www.siemens.com/specifications>

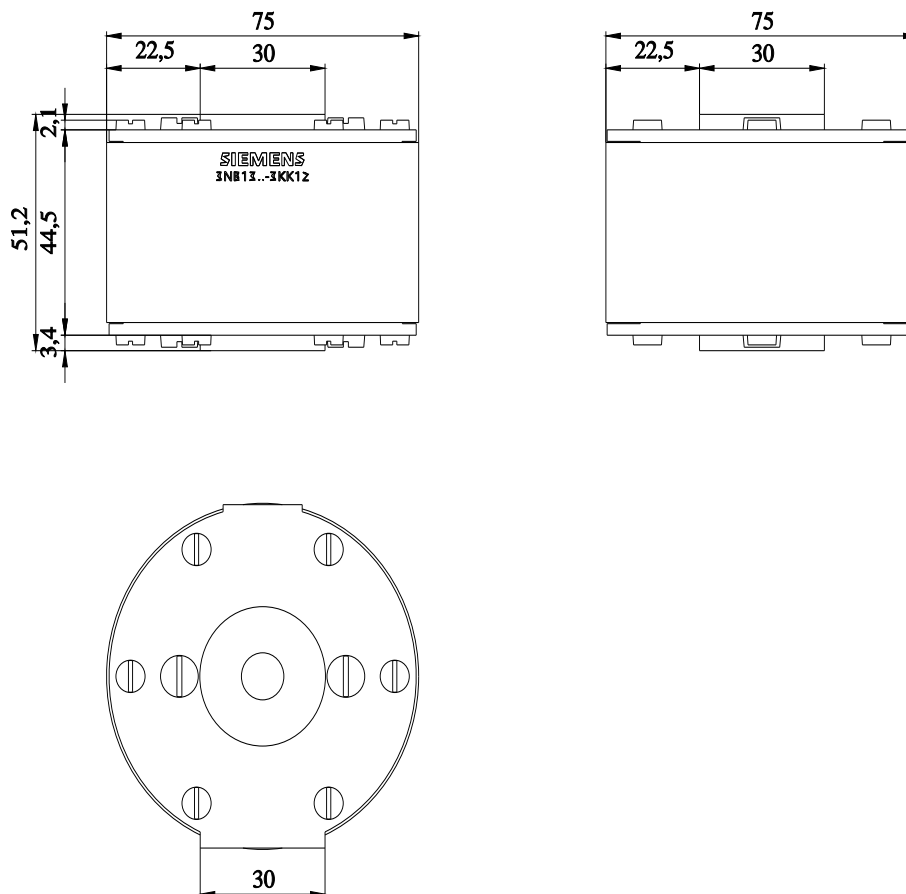

last modified:

4/24/2024

