



reversing contactor assembly, AC-3e/AC-3, 9 A, 4 kW / 400 V, 3-pole, 24 V DC, screw terminal, electrical and mechanical interlock, auxiliary contacts: 2 x 1 NO

product brand name	SIRIUS
product designation	Reversing contactor assembly
product type designation	3RA23
manufacturer's article number	
<ul style="list-style-type: none"> • 1 of the supplied contactor • 2 of the supplied contactor • of the supplied RH assembly kit 	3RT2023-1AK60 3RT2023-1AK60 3RA2923-2AA1
General technical data	
size of contactor	S0
product extension auxiliary switch	Yes
shock resistance at rectangular impulse	
<ul style="list-style-type: none"> • at AC • at DC 	7,5g / 5 ms, 4,7g / 10 ms 10g / 5 ms, 7,5g / 10 ms
shock resistance with sine pulse	
<ul style="list-style-type: none"> • at AC • at DC 	11,8g / 5 ms, 7,4g / 10 ms 15g / 5 ms, 10g / 10 ms
mechanical service life (operating cycles)	
<ul style="list-style-type: none"> • of contactor typical • of the contactor with added auxiliary switch block typical 	10 000 000 10 000 000
reference code according to IEC 81346-2	Q
Substance Prohibition (Date)	10/01/2009
Weight	1.33 kg
Ambient conditions	
installation altitude at height above sea level maximum	2 000 m
ambient temperature	
<ul style="list-style-type: none"> • during operation • during storage 	-25 ... +60 °C -55 ... +80 °C
Main circuit	
number of poles for main current circuit	3
number of NO contacts for main contacts	3
number of NC contacts for main contacts	0
operating voltage	
<ul style="list-style-type: none"> • at AC-3 rated value maximum • at AC-3e rated value maximum 	690 V 690 V
operational current	
<ul style="list-style-type: none"> • at AC-3 <ul style="list-style-type: none"> — at 400 V rated value — at 500 V rated value — at 690 V rated value • at AC-3e 	9 A 9 A 9 A

— at 400 V rated value	9 A
— at 500 V rated value	9 A
— at 690 V rated value	9 A
operating power	
● at AC-3	
— at 400 V rated value	4 kW
— at 500 V rated value	4 kW
— at 690 V rated value	7.5 kW
● at AC-3e	
— at 400 V rated value	4 kW
— at 690 V rated value	7.5 kW
● at AC-4 at 400 V rated value	4 kW
operating frequency	
● at AC-3 maximum	1 000 1/h
● at AC-3e maximum	1 000 1/h
Control circuit/ Control	
type of voltage of the control supply voltage	DC
control supply voltage 1 at DC rated value	24 V
Auxiliary circuit	
number of NO contacts for auxiliary contacts	
● per direction of rotation	1
● instantaneous contact	2
contact reliability of auxiliary contacts	< 1 error per 100 million operating cycles
UL/CSA ratings	
full-load current (FLA) for 3-phase AC motor	
● at 480 V rated value	7.6 A
● at 600 V rated value	9 A
yielded mechanical performance [hp] for 3-phase AC motor	
● at 220/230 V rated value	3 hp
● at 460/480 V rated value	5 hp
● at 575/600 V rated value	7.5 hp
contact rating of auxiliary contacts according to UL	A600 / Q600
Short-circuit protection	
design of the fuse link	
● for short-circuit protection of the main circuit	
— with type of coordination 1 required	gG NH 3NA, DIAZED 5SB, NEOZED 5SE: 63 A
— with type of assignment 2 required	gG NH 3NA, DIAZED 5SB, NEOZED 5SE: 25 A
● for short-circuit protection of the auxiliary switch required	fuse gG: 10 A
Installation/ mounting/ dimensions	
mounting position	+/-180° rotation possible on vertical mounting surface; can be tilted forward and backward by +/- 22.5° on vertical mounting surface
fastening method	screw and snap-on mounting onto 35 mm DIN rail
height	101 mm
width	90 mm
depth	97 mm
required spacing	
● with side-by-side mounting	
— forwards	6 mm
— backwards	0 mm
— upwards	6 mm
— downwards	6 mm
— at the side	6 mm
● for grounded parts	
— forwards	6 mm
— backwards	0 mm
— upwards	6 mm
— at the side	6 mm
— downwards	6 mm
● for live parts	
— forwards	6 mm
— backwards	0 mm

— upwards	6 mm
— downwards	6 mm
— at the side	6 mm

Connections/ Terminals

type of electrical connection	
<ul style="list-style-type: none"> • for main current circuit • for auxiliary and control circuit • at contactor for auxiliary contacts • of magnet coil 	screw-type terminals screw-type terminals Screw-type terminals Screw-type terminals
type of connectable conductor cross-sections for main contacts	
<ul style="list-style-type: none"> • solid • solid or stranded • finely stranded with core end processing 	2x (1 ... 2.5 mm ²), 2x (2.5 ... 10 mm ²) 2x (1 ... 2.5 mm ²), 2x (2.5 ... 10 mm ²) 2x (1 ... 2.5 mm ²), 2x (2.5 ... 6 mm ²), 1x 10 mm ²
type of connectable conductor cross-sections	
<ul style="list-style-type: none"> • for auxiliary contacts <ul style="list-style-type: none"> — solid or stranded — finely stranded with core end processing • for AWG cables for auxiliary contacts 	2x (0.5 ... 1.5 mm ²), 2x (0.75 ... 2.5 mm ²) 2x (0.5 ... 1.5 mm ²), 2x (0.75 ... 2.5 mm ²) 2x (20 ... 16), 2x (18 ... 14)





Safety related data

product function suitable for safety function	Yes
Electrical Safety	
protection class IP on the front according to IEC 60529	IP20
touch protection on the front according to IEC 60529	finger-safe, for vertical contact from the front

Communication/ Protocol

product function bus communication	Yes
protocol is supported AS-Interface protocol	No
product function control circuit interface with IO link	No

Approvals Certificates

General Product Approval	Test Certificates
 	 
Confirmation	Special Test Certificate

Marine / Shipping

					
---	---	---	---	---	---

other	Railway	Dangerous goods	Environment
Confirmation	Special Test Certificate	Transport Information	Environmental Confirmations

Further information

Information on the packaging
<https://support.industry.siemens.com/cs/ww/en/view/109813875>
 Information- and Downloadcenter (Catalogs, Brochures,...)
<https://www.siemens.com/ic10>
 Industry Mall (Online ordering system)
<https://mall.industry.siemens.com/mall/en/en/Catalog/product?mlfb=3RA2323-8XB30-1BB4>
 Cax online generator
<http://support.automation.siemens.com/WW/CAXorder/default.aspx?lang=en&mlfb=3RA2323-8XB30-1BB4>
 Service&Support (Manuals, Certificates, Characteristics, FAQs,...)
<https://support.industry.siemens.com/cs/ww/en/ps/3RA2323-8XB30-1BB4>
 Image database (product images, 2D dimension drawings, 3D models, device circuit diagrams, EPLAN macros, ...)
http://www.automation.siemens.com/bilddb/cax_de.aspx?mlfb=3RA2323-8XB30-1BB4&lang=en
 Characteristic: Tripping characteristics, I_t, Let-through current

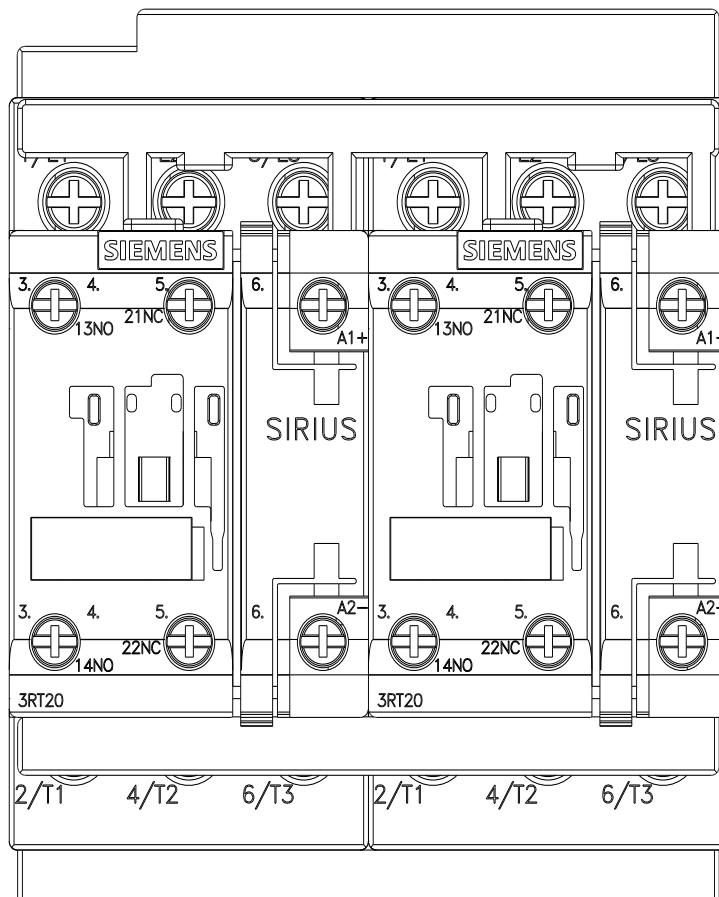
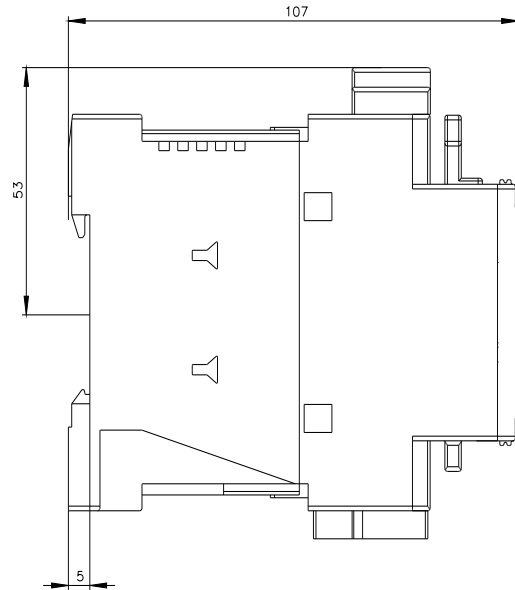
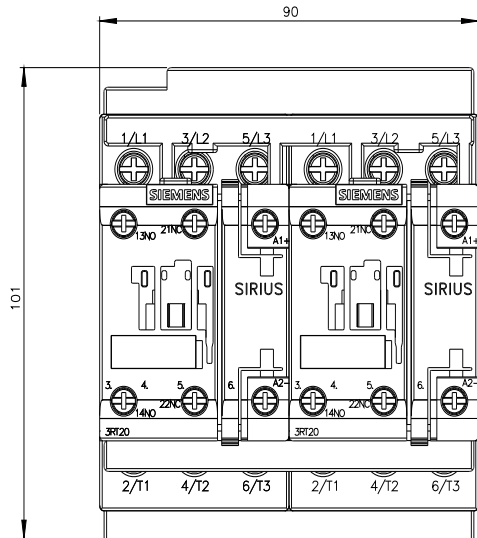

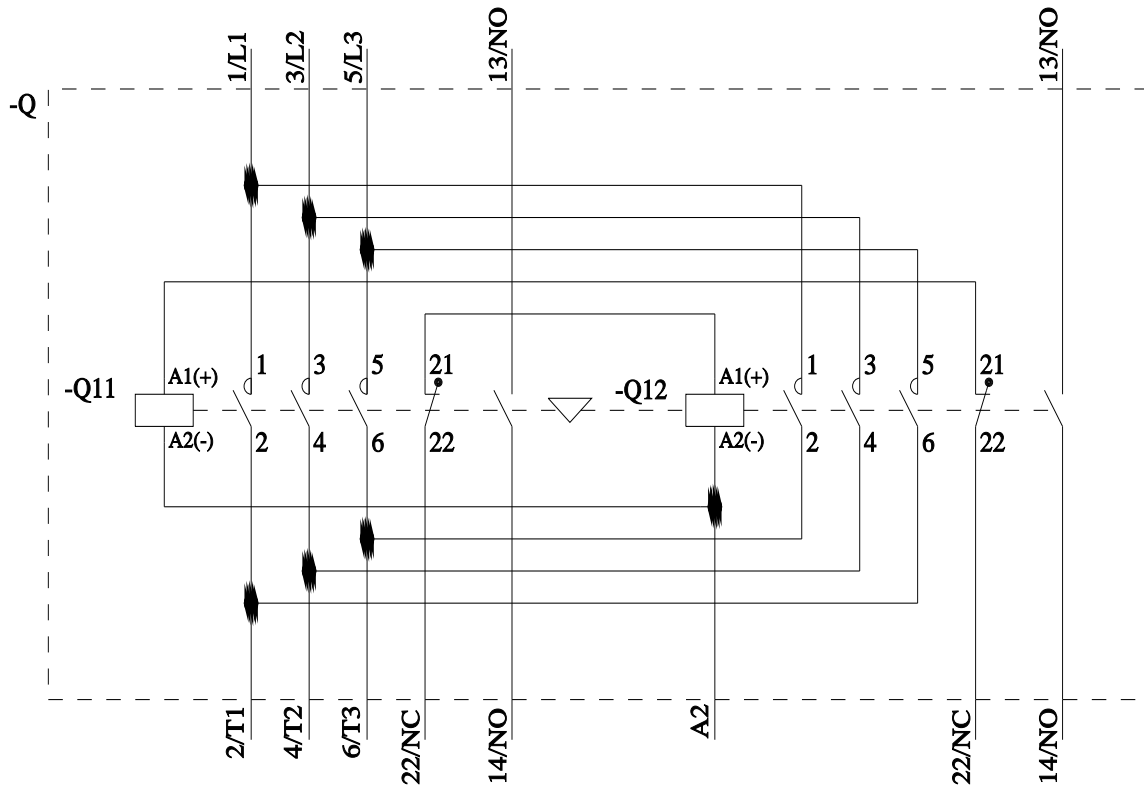

last modified:

7/9/2024 