

INDICATOR LIGHT, 22MM, ROUND, METAL, CELAR, SMOOTH LENS, WITH HOLDER, Z=50X PACK



Figure similar

Design of the product	Single device round
Enclosure:	
Number of command points	0
Actuator:	
Design of the operating mechanism	indicator light
Product extension optional Light source	Yes
Color	
• of the actuating element	Clear
Material of the actuating element	plastic
Shape of the actuating element	Smooth lens
Outer diameter of the actuating element	28 mm
Number of switching positions	0
Front ring:	
Product component front ring	No
Holder:	
Material of the holder	Metal

General technical data:

Product function	
<ul style="list-style-type: none"> • EMERGENCY OFF function • EMERGENCY STOP function 	<p>No</p> <p>No</p>
Protection class IP	IP67
Vibration resistance	
<ul style="list-style-type: none"> • acc. to IEC 60068-2-6 	20 ... 200 Hz: 5g
Equipment marking	
<ul style="list-style-type: none"> • acc. to DIN 40719 extended according to IEC 204-2 acc. to IEC 750 • acc. to DIN EN 61346-2 • acc. to DIN EN 81346-2 	<p>H</p> <p>P</p> <p>P</p>

Connections/ Terminals:

Tightening torque of the screws in the bracket	1.4 ... 1.6 N·m
---	-----------------









Ambient conditions:

Ambient temperature	
<ul style="list-style-type: none"> • during operation • during storage 	<p>-25 ... +70 °C</p> <p>-40 ... +80 °C</p>
Environmental category during operation acc. to IEC 60721	3K6

Installation/ mounting/ dimensions:

Mounting type	front mounting
Shape of the installation opening	round
Mounting diameter	22 mm
Mounting height	11 mm
Installation width	28 mm
Installation depth	29 mm

Certificates/approvals

General Product Approval			Declaration of Conformity	Shipping Approval		
 CSA	 UL		 EG-Konf.	 ABS	 DNV	
Shipping Approval			other			
 LRS	 PRS	 RINA	Bestätigungen			

Further information

Information- and Downloadcenter (Catalogs, Brochures,...)

<http://www.siemens.com/industrial-controls/catalogs>

Industry Mall (Online ordering system)

<https://mall.industry.siemens.com/mall/en/en/Catalog/product?mlfb=3SB3501-6AA70-Z X90>

Cax online generator

<http://support.automation.siemens.com/WW/CAXorder/default.aspx?lang=en&mlfb=3SB3501-6AA70-Z X90>

Service&Support (Manuals, Certificates, Characteristics, FAQs,...)

<https://support.industry.siemens.com/cs/ww/en/ps/3SB3501-6AA70-Z X90>

Image database (product images, 2D dimension drawings, 3D models, device circuit diagrams, EPLAN macros, ...)

http://www.automation.siemens.com/bilddb/cax_de.aspx?mlfb=3SB3501-6AA70-Z X90&lang=en

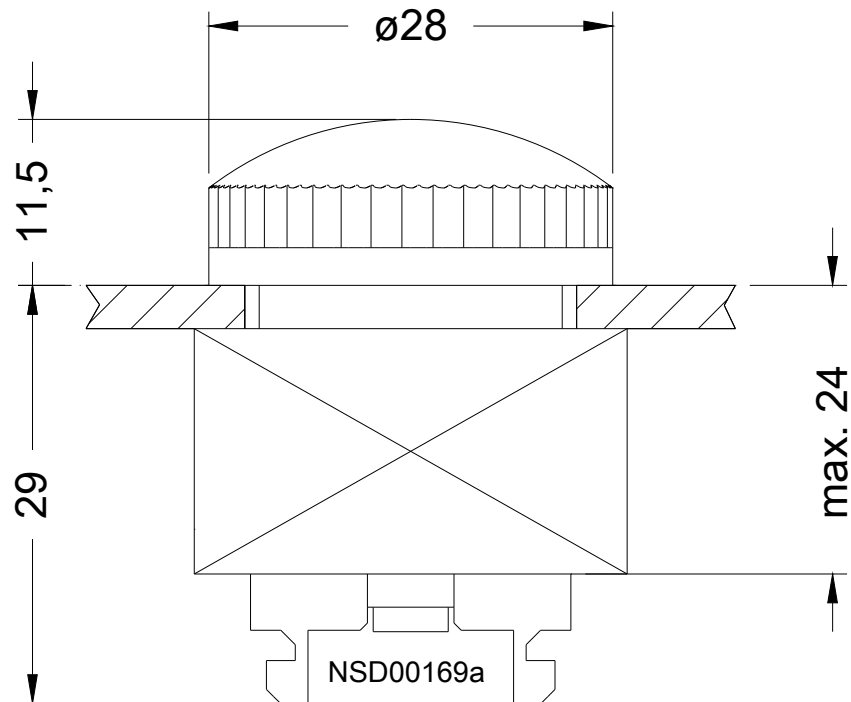

last modified:

08/18/2016