

# CB TM1 4A SFB P - Thermal-magnetic device circuit breaker



2800839

<https://www.phoenixcontact.com/gb/products/2800839>

Please be informed that the data shown in this PDF document is generated from our online catalog. Please find the complete data in the user documentation. Our general terms of use for downloads are valid.



Thermal-magnetic device circuit breaker, 1-pos., tripping characteristic SFB, 1 changeover contact, plug for base element.

## Your advantages

- Individually adjustable with protective plugs
- Fuse protection for above-average conductor lengths with the aid of the SFB characteristic curve
- Protective plug with fixed nominal current value as protection against unintentional changes
- Increased safety with electrical isolation in the event of errors

## Commercial data

Item number	2800839
Packing unit	1 pc
Minimum order quantity	1 pc
Sales key	CLA124
Product key	CLA124
GTIN	4046356689908
Weight per piece (including packing)	44.4 g
Weight per piece (excluding packing)	44.4 g
Customs tariff number	85362010
Country of origin	ID

# CB TM1 4A SFB P - Thermal-magnetic device circuit breaker



2800839

<https://www.phoenixcontact.com/gb/products/2800839>

## Technical data

### Notes

General	When mounted in rows, the nominal device current can be limited to just 80% or must be overdimensioned accordingly.
---------	---

### Product properties

Product type	Thermomagnetic device circuit breakers
Product family	CB TM
Type	Male
Number of positions	1
No. of channels	1

### Insulation characteristics

Degree of pollution	2
---------------------	---

### Electrical properties

Fuse type	Automatic device
-----------	------------------

### General

Rated voltage	50 V DC (IEC 60934)
	50 V DC (UL 1077)
	50 V DC (UL 508 - with plug-in base)
Rated insulation voltage $U_i$	277 V AC (UL 1077)
	250 V AC (IEC 60934)
Rated current $I_N$	4 A (IEC 60934)
	4 A DC (low-induction load according to UL 1077)
	4 A DC (low-induction load according to UL 508 - with plug-in base)
Rated surge voltage	2.5 kV (Increased insulation in actuation area)
Insulation resistance $R_{iso}$	> 100 M $\Omega$ (500 V DC)
Auxiliary circuit	277 V AC / 0.5 A (Low-induction)
	277 V AC / 1 A (Low-induction, maximum of 2000 cycles)
	50 V DC / 1 A (Low-induction)
Type of actuation	S type
Tripping method	TM (thermal-magnetic)
Tripping level	Trip-free mechanism (positive)
Device resistance	90 m $\Omega$
Required backup fuse	16 A ( $I > I_{cn}$ )
Rated short-circuit switching capacity $I_{cn}$	600 A (50 V DC)
Short-circuit switching capacity	1000 A AC (277 V AC)
	1000 A DC (50 V DC)
Dielectric strength	3000 V AC (Actuation area)
	1500 V AC (Main to auxiliary circuit)
	1500 V AC (Open main circuit)

# CB TM1 4A SFB P - Thermal-magnetic device circuit breaker



2800839

<https://www.phoenixcontact.com/gb/products/2800839>

	1000 V AC (Open auxiliary circuit)
Switching cycles, max.	6000 (at 1 x I <sub>n</sub> )
Fuse	SFB
Power dissipation	1.44 W (in nominal operation per channel)
Voltage drop	0.34 V (at 1 x I <sub>n</sub> )
Contact switching type	1 changeover contact

## Auxiliary contact

Minimum operating voltage U <sub>min</sub> DC	10 V
Maximum operating voltage U <sub>max</sub> DC	240 V
Maximum operating voltage U <sub>max</sub> AC	240 V
Minimum operating current I <sub>min</sub>	10 mA
Max. operating current I <sub>max</sub>	1 A

## Connection data

Connection method	pluggable
Connection method	pluggable

## Dimensions

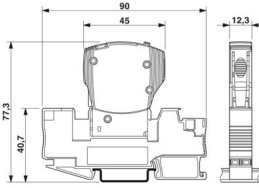
Dimensional drawing	
Width	12.3 mm
Height	45 mm
Depth	52 mm
Complete module width	12.3 mm
Complete module height	90 mm
Complete module depth	77.3 mm

## Material specifications

Color	gray (RAL 7042)
	black (RAL 9005)
Flammability rating according to UL 94	V-0
Insulating material group	II

## Mechanical properties

### Mechanical data

Open side panel	No
-----------------	----

## Environmental and real-life conditions

### Ambient conditions

# CB TM1 4A SFB P - Thermal-magnetic device circuit breaker



2800839

<https://www.phoenixcontact.com/gb/products/2800839>

Degree of protection	IP30 (Actuation area)
Ambient temperature (operation)	-30 °C ... 60 °C
Ambient temperature (storage/transport)	-40 °C ... 80 °C
Humidity test	240 h, 95 % RH, 40 °C
Shock (operation)	30g (IEC 60068-2-27, Test Ea)
Vibration (operation)	8g (IEC 60068-2-6, Test Fc)

## Approvals

### UL approval

Identification	UL Listed UL 508
	UL/C-UL Recognized UL 1077

### CSA

Identification	CSA CAN/CSA-C22.2 No. 235-04
----------------	------------------------------

### Shipbuilding approval

Identification	DNV GL
----------------	--------

## Standards and regulations

Standards/specifications	EN 60934
--------------------------	----------

## Mounting

Mounting type	on base element
---------------	-----------------

# CB TM1 4A SFB P - Thermal-magnetic device circuit breaker

2800839

<https://www.phoenixcontact.com/gb/products/2800839>

## Drawings



The figure shows the complete module consisting of a base element and connector



# CB TM1 4A SFB P - Thermal-magnetic device circuit breaker



2800839

<https://www.phoenixcontact.com/gb/products/2800839>

Application drawing



Diagram



Trigger characteristic in the DC range

# CB TM1 4A SFB P - Thermal-magnetic device circuit breaker

2800839

<https://www.phoenixcontact.com/gb/products/2800839>

Circuit diagram



# CB TM1 4A SFB P - Thermal-magnetic device circuit breaker



2800839

<https://www.phoenixcontact.com/gb/products/2800839>

## Approvals

To download certificates, visit the product detail page: <https://www.phoenixcontact.com/gb/products/2800839>



**cUL Recognized**  
Approval ID: FILE E 140459



**UL Recognized**  
Approval ID: FILE E 140459



**DNV GL**  
Approval ID: TAE00003C7



**VDE Zeichengenehmigung**  
Approval ID: 40034683



**UL Listed**  
Approval ID: FILE E 172140



**CCC**  
Approval ID: 2025010307749779



**CSA**  
Approval ID: 2786957



**cUL Listed**  
Approval ID: FILE E 172140



**KC**  
Approval ID: SW05012-15002

**UAE-RoHS**

Approval ID: 22-09-50937

# CB TM1 4A SFB P - Thermal-magnetic device circuit breaker



2800839

<https://www.phoenixcontact.com/gb/products/2800839>

## Classifications

### ECLASS

ECLASS-13.0	27140401
ECLASS-15.0	27140401

### ETIM

ETIM 9.0	EC003538
----------	----------

### UNSPSC

UNSPSC 21.0	39121400
-------------	----------

# CB TM1 4A SFB P - Thermal-magnetic device circuit breaker



2800839

<https://www.phoenixcontact.com/gb/products/2800839>

## Environmental product compliance

### EU RoHS

Fulfills EU RoHS substance requirements	Yes, No exemptions
---	--------------------

### China RoHS

Environment friendly use period (EFUP)	EFUP-E
	No hazardous substances above the limits

### EU REACH SVHC

REACH candidate substance (CAS No.)	No substance above 0.1 wt%
-------------------------------------	----------------------------

### EF3.0 Climate Change

CO2e kg	6.233 kg CO2e
---------	---------------

Phoenix Contact 2025 © - all rights reserved  
<https://www.phoenixcontact.com>

PHOENIX CONTACT Ltd  
Halesfield 13, Telford  
Shropshire, TF7 4PG  
01952 681700  
[info@phoenixcontact.co.uk](mailto:info@phoenixcontact.co.uk)