



Main miniature circuit breaker (SHU), 3-pole, E 25, 400V

Figure similar

Model	
product brand name	SENTRON
product designation	Miniature circuit breaker
design of the product	Main miniature circuit breaker
design of the locking device	Integrated locking slide, lockable by means of a lock, wire seal and cable ties
General technical data	
number of poles	3
design of pole	3P
tripping characteristic class	E
mechanical service life (operating cycles) typical	20 000
overvoltage category	4
degree of pollution	3
Voltage	
insulation voltage (Ui) rated value	690 V
surge voltage resistance rated value	6 kV
operational current	
• at 30 °C rated value	25 A
• at 40 °C rated value	23.75 A
• at 50 °C rated value	22.5 A
• at 55 °C rated value	21.875 A
• at AC rated value	25 A
Supply voltage	
supply voltage at AC	400 V
operating voltage rated value	
• minimum	110 V
• maximum	440 V
supply voltage frequency rated value	50 Hz
Protection class	
protection class IP	IP40, with connected conductors
Breaking Capacity	
switching capacity current	
• rated value	25 kA
• according to EN 60898 rated value	25 kA
Dissipation	
power loss [W] for rated value of the current at AC in hot operating state per pole	6.5 W
suitability for operation	Residential buildings/infrastructure
Product details	
product component	

• infeed at box terminal	Yes
• saddle terminals	Yes
product feature properties for main switches in accordance with EN 60204-1	Yes
product feature sealable	Yes

Display and operation

display version for switch position indicator	OFF = green, ON = red
---	-----------------------

Connections

connectable conductor cross-section of the box terminal	
• solid minimum	2.5 mm ²
• solid maximum	50 mm ²
• stranded minimum	2.5 mm ²
• stranded maximum	50 mm ²
connectable conductor cross-section solid	
• minimum	2.5 mm ²
• maximum	50 mm ²
connectable conductor cross-section stranded	
• minimum	2.5 mm ²
• maximum	50 mm ²
connectable conductor cross-section finely stranded with core end processing	
• minimum	2.5 mm ²
• maximum	50 mm ²
position of power supply cord	Any

Mechanical Design

height	128 mm
depth	76.3 mm
depth of the enclosure	76.3 mm
number of modular width units	4.5
fastening method	DIN rail
fastening method other	on DIN rail 35 mm acc. to EN 60715
Net Weight	1.09 kg

Environmental conditions

shock resistance	30 g, at least 3 impacts, impact duration 11 ms
vibration resistance according to IEC 60068-2-6	2 g, 20 frequency cycles 5 to 150 to 15 Hz
ambient temperature during operation	
• minimum	-25 °C
• maximum	55 °C
ambient temperature during storage	
• minimum	-40 °C
• maximum	70 °C

Approvals Certificates

General Product Approval	other
--------------------------	-------



[Confirmation](#)

Environment

[Environmental Confirmations](#)

[Environmental Confirmations](#)

Further information

Information on the packaging
<https://support.industry.siemens.com/cs/ww/en/view/109813875>
 Information- and Downloadcenter (Catalogs, Brochures,...)
<http://www.siemens.com/lowvoltage/catalogs>
 Industry Mall (Online ordering system)

<https://mall.industry.siemens.com/mall/en/en/Catalog/product?mlfb=5SP3325-3>

Service&Support (Manuals, Certificates, Characteristics, FAQs,...)

<https://support.industry.siemens.com/cs/ww/en/ps/5SP3325-3>

Image database (product images, 2D dimension drawings, 3D models, device circuit diagrams, ...)

http://www.automation.siemens.com/bilddb/cax_en.aspx?mlfb=5SP3325-3

CAX-Online-Generator

<http://www.siemens.com/cax>

Tender specifications

<http://www.siemens.com/specifications>

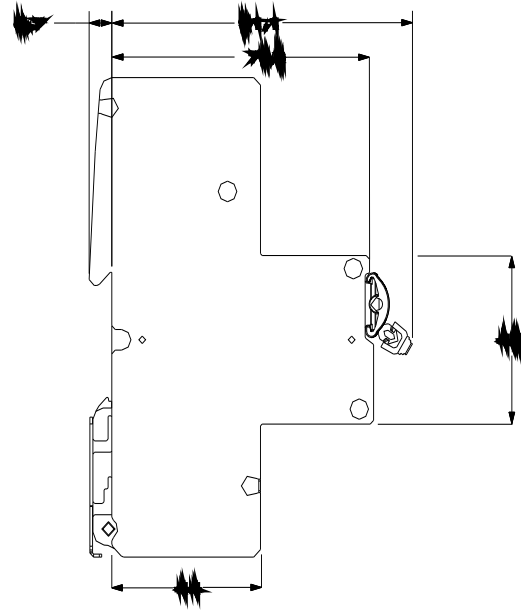
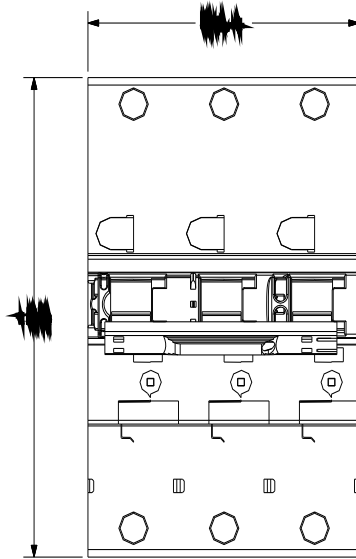



last modified:

7/22/2025 

