



power contactor, AC-3e/AC-3, 95 A, 45 kW / 400 V, 3-pole, 175-280 V AC/DC, 50/60 Hz, with integrated varistor, auxiliary contacts: 1 NO + 1 NC, main circuit: screw terminal, control and auxiliary circuit: spring-loaded terminal, size: S3

product brand name	SIRIUS
product designation	Power contactor
product type designation	3RT2
General technical data	
size of contactor	S3
product extension	
• function module for communication	No
• auxiliary switch	Yes
power loss [W] for rated value of the current	
• at AC in hot operating state	19.8 W
• at AC in hot operating state per pole	6.6 W
• without load current share typical	1.8 W
type of calculation of power loss depending on pole	quadratic
insulation voltage	
• of main circuit with degree of pollution 3 rated value	1 000 V
• of auxiliary circuit with degree of pollution 3 rated value	690 V
surge voltage resistance	
• of main circuit rated value	8 kV
• of auxiliary circuit rated value	6 kV
maximum permissible voltage for protective separation between coil and main contacts according to EN 60947-1	690 V
shock resistance at rectangular impulse	
• at AC	10.3g / 5 ms, 6. g / 10 ms
• at DC	6.7 g / 5 ms, 4g / 10 ms
shock resistance with sine pulse	
• at AC	16.3g / 5 ms, 10.g / 10 ms
• at DC	10.6 g / 5 ms, 6.3 g / 10 ms
mechanical service life (operating cycles)	
• of contactor typical	10 000 000
• of the contactor with added electronically optimized auxiliary switch block typical	5 000 000
• of the contactor with added auxiliary switch block typical	10 000 000
reference code according to IEC 81346-2	Q
Substance Prohibition (Date)	03/01/2017
SVHC substance name	Lead - 7439-92-1 Lead monoxide (lead oxide) - 1317-36-8 2-methyl-1-(4-methylthiophenyl)-2-morpholinopropan-1-one - 71868-10-5
Weight	1.804 kg
Ambient conditions	
installation altitude at height above sea level maximum	2 000 m
ambient temperature	

<ul style="list-style-type: none"> during operation during storage 	-25 ... +60 °C
	-55 ... +80 °C
relative humidity minimum	10 %
relative humidity at 55 °C according to IEC 60068-2-30 maximum	95 %
Environmental footprint	
Environmental Product Declaration(EPD)	Yes
global warming potential [CO2 eq] total	267 kg
global warming potential [CO2 eq] during manufacturing	9.35 kg
global warming potential [CO2 eq] during operation	259 kg
global warming potential [CO2 eq] after end of life	-1.55 kg
Main circuit	
number of poles for main current circuit	3
number of NO contacts for main contacts	3
operating voltage	
<ul style="list-style-type: none"> at AC-3 rated value maximum at AC-3e rated value maximum 	1 000 V
	1 000 V
operational current	
<ul style="list-style-type: none"> at AC-1 at 400 V at ambient temperature 40 °C rated value at AC-1 <ul style="list-style-type: none"> up to 690 V at ambient temperature 40 °C rated value up to 690 V at ambient temperature 60 °C rated value at AC-3 <ul style="list-style-type: none"> at 400 V rated value at 500 V rated value at 690 V rated value at 1000 V rated value at AC-3e <ul style="list-style-type: none"> at 400 V rated value at 500 V rated value at 690 V rated value at 1000 V rated value at AC-4 at 400 V rated value at AC-5a up to 690 V rated value at AC-5b up to 400 V rated value at AC-6a <ul style="list-style-type: none"> up to 230 V for current peak value n=20 rated value up to 400 V for current peak value n=20 rated value up to 500 V for current peak value n=20 rated value up to 690 V for current peak value n=20 rated value at AC-6a <ul style="list-style-type: none"> up to 230 V for current peak value n=30 rated value up to 400 V for current peak value n=30 rated value up to 500 V for current peak value n=30 rated value up to 690 V for current peak value n=30 rated value 	130 A
	130 A
	110 A
	95 A
	95 A
	78 A
	30 A
	95 A
	95 A
	78 A
	30 A
	80 A
	114 A
	95 A
	84.4 A
	84.4 A
	84.4 A
	58 A
	56.3 A
	56.3 A
	56.3 A
	56.3 A
minimum cross-section in main circuit at maximum AC-1 rated value	50 mm ²
operational current for approx. 200000 operating cycles at AC-4	
<ul style="list-style-type: none"> at 400 V rated value at 690 V rated value 	42 A
	30 A
operational current	
<ul style="list-style-type: none"> at 1 current path at DC-1 <ul style="list-style-type: none"> at 24 V rated value at 60 V rated value at 110 V rated value at 220 V rated value at 440 V rated value at 600 V rated value 	100 A
	60 A
	9 A
	2 A
	0.6 A
	0.4 A

<ul style="list-style-type: none"> ● with 2 current paths in series at DC-1 <ul style="list-style-type: none"> — at 24 V rated value — at 60 V rated value — at 110 V rated value — at 220 V rated value — at 440 V rated value — at 600 V rated value ● with 3 current paths in series at DC-1 <ul style="list-style-type: none"> — at 24 V rated value — at 60 V rated value — at 110 V rated value — at 220 V rated value — at 440 V rated value — at 600 V rated value ● at 1 current path at DC-3 at DC-5 <ul style="list-style-type: none"> — at 24 V rated value — at 60 V rated value — at 110 V rated value — at 220 V rated value — at 440 V rated value — at 600 V rated value ● with 2 current paths in series at DC-3 at DC-5 <ul style="list-style-type: none"> — at 24 V rated value — at 60 V rated value — at 110 V rated value — at 220 V rated value — at 440 V rated value — at 600 V rated value ● with 3 current paths in series at DC-3 at DC-5 <ul style="list-style-type: none"> — at 24 V rated value — at 60 V rated value — at 110 V rated value — at 220 V rated value — at 440 V rated value — at 600 V rated value 	<p>100 A</p> <p>100 A</p> <p>100 A</p> <p>10 A</p> <p>1.8 A</p> <p>1 A</p> <p>100 A</p> <p>100 A</p> <p>100 A</p> <p>80 A</p> <p>4.5 A</p> <p>2.6 A</p> <p>40 A</p> <p>6 A</p> <p>2.5 A</p> <p>1 A</p> <p>0.15 A</p> <p>0.06 A</p> <p>100 A</p> <p>100 A</p> <p>100 A</p> <p>7 A</p> <p>0.42 A</p> <p>0.16 A</p> <p>100 A</p> <p>100 A</p> <p>100 A</p> <p>35 A</p> <p>0.8 A</p> <p>0.35 A</p>
<p>operating power</p> <ul style="list-style-type: none"> ● at AC-2 at 400 V rated value ● at AC-3 <ul style="list-style-type: none"> — at 230 V rated value — at 400 V rated value — at 500 V rated value — at 690 V rated value — at 1000 V rated value ● at AC-3e <ul style="list-style-type: none"> — at 230 V rated value — at 400 V rated value — at 500 V rated value — at 690 V rated value — at 1000 V rated value 	<p>45 kW</p> <p>22 kW</p> <p>45 kW</p> <p>55 kW</p> <p>75 kW</p> <p>37 kW</p> <p>22 kW</p> <p>45 kW</p> <p>55 kW</p> <p>75 kW</p> <p>37 kW</p>
<p>operating power for approx. 200000 operating cycles at AC-4</p> <ul style="list-style-type: none"> ● at 400 V rated value ● at 690 V rated value 	<p>22 kW</p> <p>27.4 kW</p>
<p>operating apparent power at AC-6a</p> <ul style="list-style-type: none"> ● up to 230 V for current peak value n=20 rated value ● up to 400 V for current peak value n=20 rated value ● up to 500 V for current peak value n=20 rated value ● up to 690 V for current peak value n=20 rated value 	<p>33 kVA</p> <p>58 kVA</p> <p>73 kVA</p> <p>69 kVA</p>
<p>operating apparent power at AC-6a</p> <ul style="list-style-type: none"> ● up to 230 V for current peak value n=30 rated value ● up to 400 V for current peak value n=30 rated value 	<p>22.4 kVA</p> <p>39 kVA</p>

<ul style="list-style-type: none"> • up to 500 V for current peak value n=30 rated value • up to 690 V for current peak value n=30 rated value 	48.7 kVA 67.3 kVA
short-time withstand current in cold operating state up to 40 °C <ul style="list-style-type: none"> • limited to 1 s switching at zero current maximum • limited to 5 s switching at zero current maximum • limited to 10 s switching at zero current maximum • limited to 30 s switching at zero current maximum • limited to 60 s switching at zero current maximum 	1 725 A; Use minimum cross-section acc. to AC-1 rated value 1 297 A; Use minimum cross-section acc. to AC-1 rated value 946 A; Use minimum cross-section acc. to AC-1 rated value 610 A; Use minimum cross-section acc. to AC-1 rated value 486 A; Use minimum cross-section acc. to AC-1 rated value
no-load switching frequency <ul style="list-style-type: none"> • at AC • at DC 	1 000 1/h 1 000 1/h
operating frequency <ul style="list-style-type: none"> • at AC-1 maximum • at AC-2 maximum • at AC-3 maximum • at AC-3e <ul style="list-style-type: none"> — maximum • at AC-4 maximum 	900 1/h 350 1/h 850 1/h 850 1/h 250 1/h
Control circuit/ Control	
type of voltage of the control supply voltage	AC/DC
control supply voltage at AC <ul style="list-style-type: none"> • at 50 Hz rated value • at 60 Hz rated value 	175 ... 280 V 175 ... 280 V
control supply voltage at DC rated value	175 ... 280 V
operating range factor control supply voltage rated value of magnet coil at DC <ul style="list-style-type: none"> • initial value • full-scale value 	0.8 1.1
operating range factor control supply voltage rated value of magnet coil at AC <ul style="list-style-type: none"> • at 50 Hz • at 60 Hz 	0.8 ... 1.1 0.8 ... 1.1
design of the surge suppressor	with varistor
inrush current peak	65 A
duration of inrush current peak	5 µs
locked-rotor current mean value	0.44 A
locked-rotor current peak	1.2 A
duration of locked-rotor current	150 ms
holding current mean value	10 mA
apparent pick-up power of magnet coil at AC <ul style="list-style-type: none"> • at 50 Hz • at 60 Hz 	151 VA 151 VA
apparent holding power <ul style="list-style-type: none"> • at minimum rated control supply voltage at DC • at maximum rated control supply voltage at DC 	1.8 VA 1.8 VA
apparent holding power <ul style="list-style-type: none"> • at minimum rated control supply voltage at AC <ul style="list-style-type: none"> — at 50 Hz — at 60 Hz • at maximum rated control supply voltage at AC <ul style="list-style-type: none"> — at 50 Hz — at 60 Hz 	3.1 VA 3.1 VA 3.1 VA 3.1 VA
apparent holding power of magnet coil at AC <ul style="list-style-type: none"> • at 50 Hz • at 60 Hz 	3.1 VA 3.1 VA
inductive power factor with the holding power of the coil <ul style="list-style-type: none"> • at 50 Hz • at 60 Hz 	0.95 0.95
closing power of magnet coil at DC	76 W
holding power of magnet coil at DC	1.8 W
closing delay	

<ul style="list-style-type: none"> • at AC • at DC 	50 ... 70 ms
opening delay	
<ul style="list-style-type: none"> • at AC • at DC 	38 ... 57 ms
arcing time	10 ... 20 ms
control version of the switch operating mechanism	Standard A1 - A2
Auxiliary circuit	
number of NC contacts for auxiliary contacts instantaneous contact	1
number of NO contacts for auxiliary contacts instantaneous contact	1
operational current at AC-12 maximum	10 A
operational current at AC-15	
<ul style="list-style-type: none"> • at 230 V rated value • at 400 V rated value • at 500 V rated value • at 690 V rated value 	6 A 3 A 2 A 1 A
operational current at DC-12	
<ul style="list-style-type: none"> • at 24 V rated value • at 48 V rated value • at 60 V rated value • at 110 V rated value • at 125 V rated value • at 220 V rated value • at 600 V rated value 	10 A 6 A 6 A 3 A 2 A 1 A 0.15 A
operational current at DC-13	
<ul style="list-style-type: none"> • at 24 V rated value • at 48 V rated value • at 60 V rated value • at 110 V rated value • at 125 V rated value • at 220 V rated value • at 600 V rated value 	10 A 2 A 2 A 1 A 0.9 A 0.3 A 0.1 A
contact reliability of auxiliary contacts	1 faulty switching per 100 million (17 V, 1 mA)
UL/CSA ratings	
full-load current (FLA) for 3-phase AC motor	
<ul style="list-style-type: none"> • at 480 V rated value • at 600 V rated value 	96 A 77 A
yielded mechanical performance [hp]	
<ul style="list-style-type: none"> • for single-phase AC motor <ul style="list-style-type: none"> — at 110/120 V rated value — at 230 V rated value • for 3-phase AC motor <ul style="list-style-type: none"> — at 200/208 V rated value — at 220/230 V rated value — at 460/480 V rated value — at 575/600 V rated value 	10 hp 20 hp 30 hp 30 hp 75 hp 75 hp
contact rating of auxiliary contacts according to UL	A600 / P600
Short-circuit protection	
design of the miniature circuit breaker for short-circuit protection of the auxiliary circuit up to 230 V	C characteristic: 10 A; 0.4 kA
design of the fuse link	
<ul style="list-style-type: none"> • for short-circuit protection of the main circuit <ul style="list-style-type: none"> — with type of coordination 1 required — with type of coordination 2 required • for short-circuit protection of the auxiliary switch required 	gG: 250 A (690 V, 100 kA), aM: 160 A (690 V, 100 kA), BS88: 200 A (415 V, 80 kA) gG: 160 A (690 V, 100 kA), aM: 100 A (690 V, 100 kA), BS88: 125 A (415 V, 80 kA) gG: 10 A (500 V, 1 kA)
Installation/ mounting/ dimensions	
mounting position	+/-180° rotation possible on vertical mounting surface; can be tilted forward and backward by +/- 22.5° on vertical mounting surface

fastening method side-by-side mounting	Yes
fastening method	screw and snap-on mounting onto 35 mm DIN rail according to DIN EN 60715
height	140 mm
width	70 mm
depth	152 mm
required spacing	
<ul style="list-style-type: none"> ● with side-by-side mounting <ul style="list-style-type: none"> — forwards 20 mm — upwards 10 mm — downwards 10 mm — at the side 0 mm ● for grounded parts <ul style="list-style-type: none"> — forwards 20 mm — upwards 10 mm — at the side 10 mm — downwards 10 mm ● for live parts <ul style="list-style-type: none"> — forwards 20 mm — upwards 10 mm — downwards 10 mm — at the side 10 mm 	

Connections/ Terminals

type of electrical connection	
<ul style="list-style-type: none"> ● for main current circuit ● for auxiliary and control circuit ● at contactor for auxiliary contacts ● of magnet coil 	screw-type terminals spring-loaded terminals Spring-type terminals Spring-type terminals
type of connectable conductor cross-sections	
<ul style="list-style-type: none"> ● for main contacts <ul style="list-style-type: none"> — finely stranded with core end processing ● for AWG cables for main contacts 	2x (2.5 ... 35 mm ²), 1x (2.5 ... 50 mm ²) 2x (10 ... 1/0), 1x (10 ... 2/0)
connectable conductor cross-section for main contacts	
<ul style="list-style-type: none"> ● solid ● stranded ● finely stranded with core end processing 	2.5 ... 16 mm ² 6 ... 70 mm ² 2.5 ... 50 mm ²
connectable conductor cross-section for auxiliary contacts	
<ul style="list-style-type: none"> ● solid or stranded ● finely stranded with core end processing ● finely stranded without core end processing 	0.5 ... 2.5 mm ² 0.5 ... 2.5 mm ² 0.5 ... 2.5 mm ²
type of connectable conductor cross-sections	
<ul style="list-style-type: none"> ● for auxiliary contacts <ul style="list-style-type: none"> — solid or stranded — finely stranded with core end processing — finely stranded without core end processing ● for AWG cables for auxiliary contacts 	2x (0.5 ... 2.5 mm ²) 2x (0.5 ... 1.5 mm ²) 2x (0.5 ... 2.5 mm ²) 2x (20 ... 16)
AWG number as coded connectable conductor cross section for auxiliary contacts	20 ... 14

Safety related data

product function	
<ul style="list-style-type: none"> ● mirror contact according to IEC 60947-4-1 ● positively driven operation according to IEC 60947-5-1 ● suitable for safety function 	Yes No Yes
suitability for use safety-related switching OFF	Yes
service life maximum	20 a
test wear-related service life necessary	Yes
proportion of dangerous failures	
<ul style="list-style-type: none"> ● with low demand rate according to SN 31920 ● with high demand rate according to SN 31920 	40 % 73 %
B10 value with high demand rate according to SN 31920	1 000 000
failure rate [FIT] with low demand rate according to SN 31920	100 FIT

ISO 13849	
device type according to ISO 13849-1	3
overdimensioning according to ISO 13849-2 necessary	Yes
IEC 61508	
safety device type according to IEC 61508-2	Type A
Electrical Safety	
protection class IP on the front according to IEC 60529	IP20
touch protection on the front according to IEC 60529	finger-safe, for vertical contact from the front

Approvals Certificates





General Product Approval







EMV	Test Certificates	Maritime application
 RCM	Special Test Certificate	Type Test Certificates/Test Report
	 ABS	 DNV
		 LRS

Maritime application	other	Railway	Environment
 PRS	 RINA	 RMRS	 EPD
	Confirmation	Special Test Certificate	

Environment

[Environmental Confirmations](#)

Further information

Information on the packaging
<https://support.industry.siemens.com/cs/ww/en/view/109813875>
 Information- and Downloadcenter (Catalogs, Brochures,...)
<https://www.siemens.com/ic10>
 Industry Mall (Online ordering system)
<https://mall.industry.siemens.com/mall/en/en/Catalog/product?mlfb=3RT2046-3NP30>
 Cax online generator
<http://support.automation.siemens.com/WWW/CAXorder/default.aspx?lang=en&mlfb=3RT2046-3NP30>
 Service&Support (Manuals, Certificates, Characteristics, FAQs,...)
<https://support.industry.siemens.com/cs/ww/en/ps/3RT2046-3NP30>
 Image database (product images, 2D dimension drawings, 3D models, device circuit diagrams, EPLAN macros, ...)
http://www.automation.siemens.com/bilddb/cax_de.aspx?mlfb=3RT2046-3NP30&lang=en
 Characteristic: Tripping characteristics, I_t, Let-through current
<https://support.industry.siemens.com/cs/ww/en/ps/3RT2046-3NP30/char>
 Further characteristics (e.g. electrical endurance, switching frequency)
<http://www.automation.siemens.com/bilddb/index.aspx?view=Search&mlfb=3RT2046-3NP30&objecttype=14&gridview=view1>

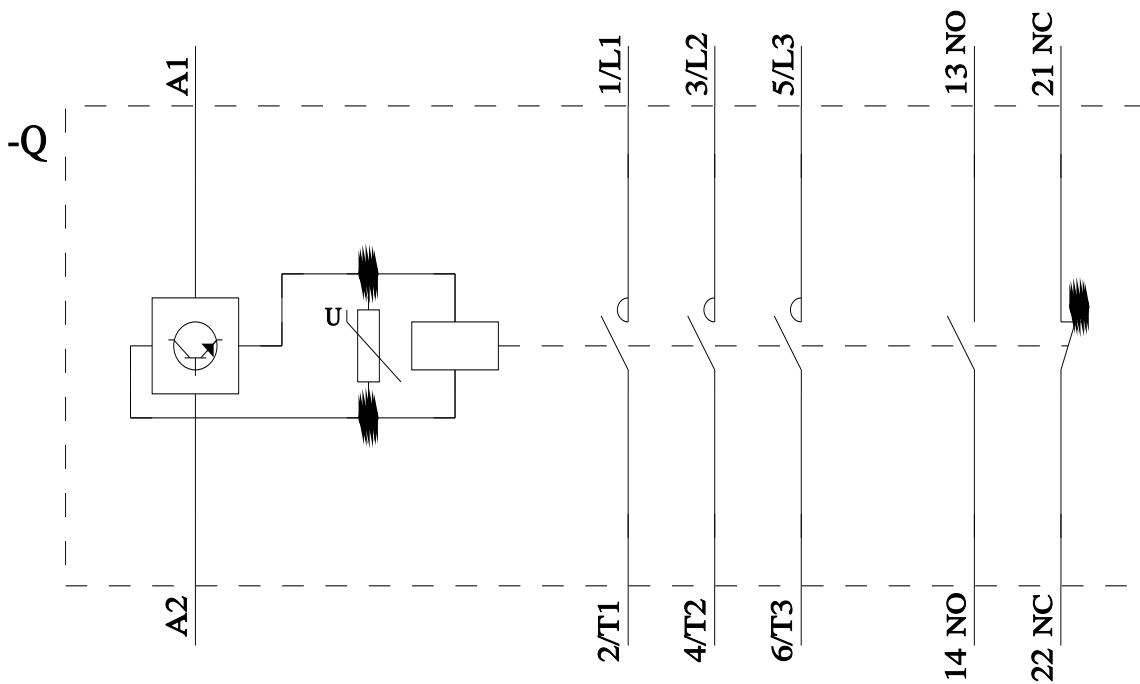
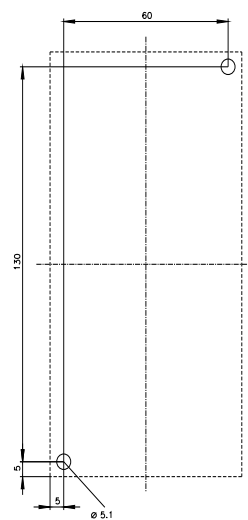
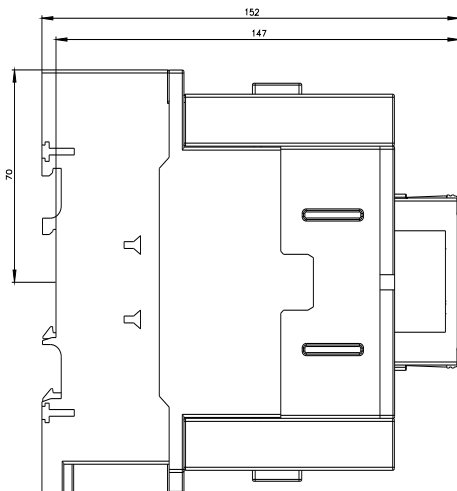
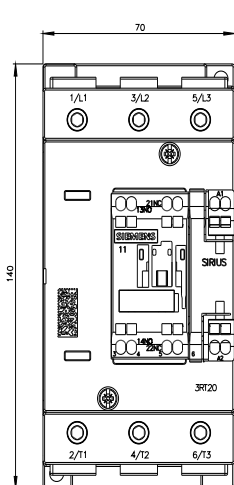

last modified:

8/22/2025

