

UT 35 RD - Feed-through terminal block



3044227

<https://www.phoenixcontact.com/gb/products/3044227>

Please be informed that the data shown in this PDF document is generated from our online catalog. Please find the complete data in the user documentation. Our general terms of use for downloads are valid.

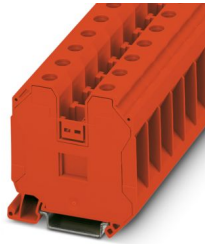

Feed-through terminal block, nom. voltage: 1000 V, nominal current: 125 A, number of connections: 2, connection method: Screw connection, Rated cross section: 35 mm², cross section: 1.5 mm² - 50 mm², mounting type: NS 35/7,5, NS 35/15, color: red

Your advantages

- The flexible options for reducing bridging in the CLIPLINE complete system can be found in "Accessories for the CLIPLINE complete modular terminal block system"
- The reducing bridges can be used to connect terminal blocks with different connection technologies, e.g., UT 35 screw terminal block with Push-in technology 2,5 Push-in terminal blocks, to form power blocks

Commercial data

Item number	3044227
Packing unit	50 pc
Minimum order quantity	50 pc
Sales key	BE1111
Product key	BE1111
GTIN	4046356781237
Weight per piece (including packing)	59.148 g
Weight per piece (excluding packing)	59.148 g
Customs tariff number	85369010
Country of origin	TR

UT 35 RD - Feed-through terminal block



3044227

<https://www.phoenixcontact.com/gb/products/3044227>

Technical data

Product properties

Product type	Feed-through terminal block
Product family	UT
Number of connections	2
Number of rows	1
Potentials	1

Insulation characteristics

Overvoltage category	III
Degree of pollution	3

Electrical properties

Rated surge voltage	8 kV
Maximum power dissipation for nominal condition	4.06 W

Connection data

Number of connections per level	2
Nominal cross section	35 mm ²

Level 1 above 1 below 1

Connection method	Screw connection
Screw thread	M6
Tightening torque	3.2 ... 3.7 Nm
Stripping length	18 mm
Internal cylindrical gage	B9
Connection in acc. with standard	IEC 60947-7-1
Conductor cross-section rigid	1.5 mm ² ... 50 mm ²
Cross section AWG	14 ... 0 (converted acc. to IEC)
Conductor cross-section flexible	1.5 mm ² ... 50 mm ²
Conductor cross-section, flexible [AWG]	14 ... 0 (converted acc. to IEC)
Conductor cross-section flexible (ferrule without plastic sleeve)	1.5 mm ² ... 35 mm ²
Flexible conductor cross-section (ferrule with plastic sleeve)	1.5 mm ² ... 35 mm ²
2 conductors with same cross section, solid	1.5 mm ² ... 16 mm ²
2 conductors with same cross section, flexible	1.5 mm ² ... 10 mm ²
2 conductors with same cross section, flexible, with ferrule without plastic sleeve	1.5 mm ² ... 10 mm ²
2 conductors with the same cross section, flexible, with TWIN ferrule with plastic sleeve	1.5 mm ² ... 16 mm ²
Nominal current	125 A
Maximum load current	150 A (with 50 mm ² conductor cross-section)
Nominal voltage	1000 V
Note	Note: Product releases, connection cross sections and notes on connecting aluminum cables can be found in the download area.

UT 35 RD - Feed-through terminal block



3044227

<https://www.phoenixcontact.com/gb/products/3044227>

Nominal cross section	35 mm ²
-----------------------	--------------------

Ex data

Rated data (ATEX/IECEX)

Identification	⊕ II 2 GD Ex eb IIC Gb
Operating temperature range	-60 °C ... 110 °C
Ex-certified accessories	1205079 SZS 1,0X6,5 VDE 3022276 CLIPFIX 35-5 3022218 CLIPFIX 35
List of bridges	Plug-in bridge / FBS 2-16 / 3005963
Bridge data	98.5 A (35 mm ²)
Ex temperature increase for bridging with bridge	40 K (133.6 A / 35 mm ²) 690 V
Rated insulation voltage output	630 V (Permanent)

Ex level General

Rated voltage	690 V
Rated current	123 A
Maximum load current	129 A
Contact resistance	0.08 mΩ

Ex connection data General

Torque range	3.2 Nm ... 3.7 Nm
Nominal cross section	35 mm ²
Rated cross section AWG	2
Connection capacity rigid	1.5 mm ² ... 50 mm ²
Connection capacity AWG	16 ... 1/0
Connection capacity flexible	1.5 mm ² ... 35 mm ²
Connection capacity AWG	16 ... 2
2 conductors with same cross section, solid	1.5 mm ² ... 16 mm ²
2 conductors with the same cross-section AWG rigid	16 ... 6
2 conductors with same cross section, stranded	1.5 mm ² ... 10 mm ²
2 conductors with the same cross-section AWG flexible	16 ... 8

Dimensions

Width	16 mm
End cover width	2.2 mm
Height	61.2 mm
Depth	65.1 mm
Depth on NS 35/7,5	65.7 mm
Depth on NS 35/15	73.2 mm

Material specifications

Color	red (RAL 3001)
-------	----------------

UT 35 RD - Feed-through terminal block



3044227

<https://www.phoenixcontact.com/gb/products/3044227>

Flammability rating according to UL 94	V0
Insulating material group	I
Insulating material	PA
Static insulating material application in cold	-60 °C
Relative insulation material temperature index (Elec., UL 746 B)	125 °C

Electrical tests

Surge voltage test

Test voltage setpoint	9.8 kV
Result	Test passed

Temperature-rise test

Requirement temperature-rise test	Increase in temperature \leq 45 K
Result	Test passed
Short-time withstand current 35 mm ²	4.2 kA
Result	Test passed

Power-frequency withstand voltage

Test voltage setpoint	2.2 kV
Result	Test passed

Mechanical properties

Mechanical data

Open side panel	No
-----------------	----

Mechanical tests

Mechanical strength

Result	Test passed
--------	-------------

Attachment on the carrier

DIN rail/fixing support	NS 35
Test force setpoint	10 N
Result	Test passed

Test for conductor damage and slacking

Rotation speed	10 rpm
Revolutions	135
Conductor cross-section/weight	1.5 mm ² / 0.4 kg
	35 mm ² / 6.8 kg
	50 mm ² / 9.5 kg
Result	Test passed

Environmental and real-life conditions

Needle-flame test

UT 35 RD - Feed-through terminal block



3044227

<https://www.phoenixcontact.com/gb/products/3044227>

Time of exposure	30 s
Result	Test passed

Oscillation/broadband noise

Specification	DIN EN 50155 (VDE 0115-200):2022-06
Spectrum	Long life test category 2, bogie-mounted
Frequency	$f_1 = 5 \text{ Hz}$ to $f_2 = 250 \text{ Hz}$
ASD level	$6.12 \text{ (m/s}^2\text{)}^2\text{/Hz}$
Acceleration	3.12g
Test duration per axis	5 h
Test directions	X-, Y- and Z-axis
Result	Test passed

Shocks

Specification	DIN EN 50155 (VDE 0115-200):2008-03
Pulse shape	Half-sine
Acceleration	5g
Shock duration	30 ms
Number of shocks per direction	3
Test directions	X-, Y- and Z-axis (pos. and neg.)
Result	Test passed

Ambient conditions

Ambient temperature (operation)	-60 °C ... 110 °C (Operating temperature range incl. self-heating; for max. short-term operating temperature, see RTI Elec.)
Ambient temperature (storage/transport)	-25 °C ... 60 °C (for a short time, not exceeding 24 h, -60 °C to +70 °C)
Ambient temperature (assembly)	-5 °C ... 70 °C
Ambient temperature (actuation)	-5 °C ... 70 °C ()
Permissible humidity (operation)	20 % ... 90 %
Permissible humidity (storage/transport)	30 % ... 70 %

Standards and regulations

Connection in acc. with standard	IEC 60947-7-1
----------------------------------	---------------

Mounting

Mounting type	NS 35/7,5
	NS 35/15

UT 35 RD - Feed-through terminal block

3044227

<https://www.phoenixcontact.com/gb/products/3044227>

Drawings

Schematic diagram

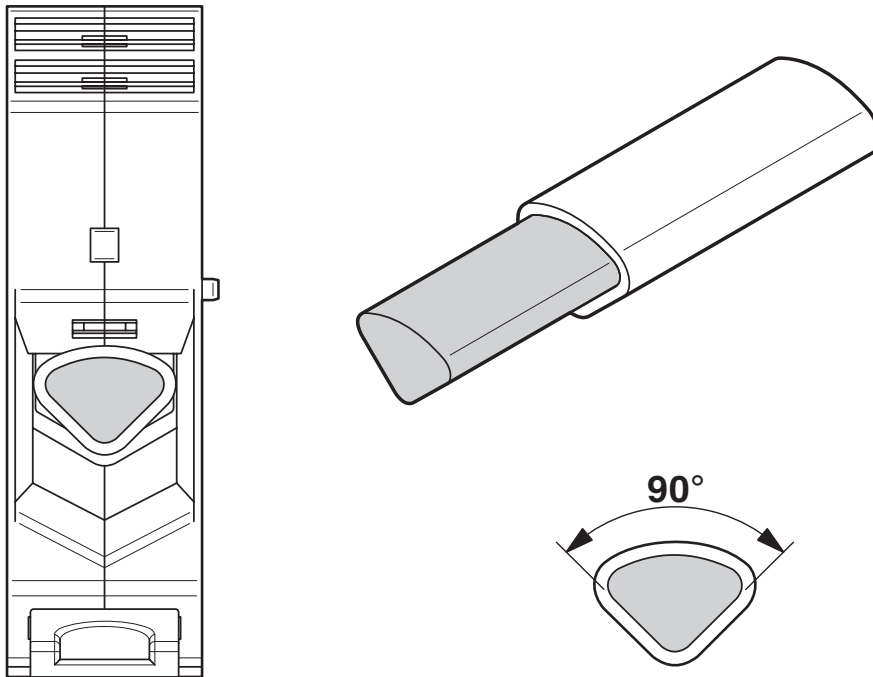

Connecting aluminum cables. Further notes can be found in the download area

Circuit diagram

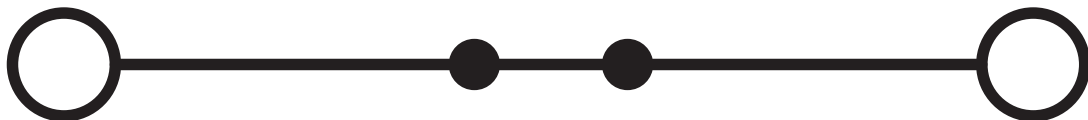

UT 35 RD - Feed-through terminal block



3044227

<https://www.phoenixcontact.com/gb/products/3044227>

Approvals

To download certificates, visit the product detail page: <https://www.phoenixcontact.com/gb/products/3044227>

DNV

Approval ID: TAE00001S9



CSA

Approval ID: 13631



IECEE CB Scheme

Approval ID: DE1-65779

	Nominal voltage U_N	Nominal current I_N	Cross section AWG	Cross section mm^2
keine				
	1000 V	125 A	-	1.5 - 35



cULus Recognized

Approval ID: E60425

	Nominal voltage U_N	Nominal current I_N	Cross section AWG	Cross section mm^2
B				
	600 V	150 A	14 - 1/0	-
Multi-conductor connection	600 V	150 A	14	-
C				
	600 V	150 A	14 - 1/0	-
Multi-conductor connection	600 V	150 A	14	-
E				
	1000 V	150 A	14 - 1/0	-
Multi-conductor connection	1000 V	150 A	14	-



VDE approval of drawings

Approval ID: 40020166

	Nominal voltage U_N	Nominal current I_N	Cross section AWG	Cross section mm^2
keine				
	1000 V	125 A	-	1.5 - 35



CSA

Approval ID: 13631

UT 35 RD - Feed-through terminal block





3044227

<https://www.phoenixcontact.com/gb/products/3044227>

 ATEX Approval ID: KEMA04ATEX2048U				
	Nominal voltage U_N	Nominal current I_N	Cross section AWG	Cross section mm^2
keine				
Only flexible conductors	690 V	123 A	-	1.5 - 35
Only rigid conductors	690 V	129 A	-	1.5 - 50

 cUL Recognized Approval ID: E192998				
	Nominal voltage U_N	Nominal current I_N	Cross section AWG	Cross section mm^2
keine				
	600 V	150 A	14 - 1/0	-

 IECEx Approval ID: IECEx KEM 06.0027U				
	Nominal voltage U_N	Nominal current I_N	Cross section AWG	Cross section mm^2
keine				
Only flexible conductors	690 V	123 A	-	1.5 - 35
Only rigid conductors	690 V	129 A	-	1.5 - 50

 UL Recognized Approval ID: E192998				
	Nominal voltage U_N	Nominal current I_N	Cross section AWG	Cross section mm^2
keine				
	600 V	150 A	14 - 1/0	-

 CCC Approval ID: 2020322313000622				
---	--	--	--	--

 UKCA-EX Approval ID: DEKRA 21UKEX0304U				
--	--	--	--	--

 EAC Ex Approval ID: KZ 7500525010101950				
---	--	--	--	--

UT 35 RD - Feed-through terminal block



3044227

<https://www.phoenixcontact.com/gb/products/3044227>

Classifications

ECLASS

ECLASS-13.0	27250101
ECLASS-15.0	27250101

ETIM

ETIM 9.0	EC000897
----------	----------

UNSPSC

UNSPSC 21.0	39121400
-------------	----------

UT 35 RD - Feed-through terminal block



3044227

<https://www.phoenixcontact.com/gb/products/3044227>

Environmental product compliance

EU RoHS

Fulfills EU RoHS substance requirements	Yes, No exemptions
---	--------------------

China RoHS

Environment friendly use period (EFUP)	EFUP-E
	No hazardous substances above the limits

EU REACH SVHC

REACH candidate substance (CAS No.)	No substance above 0.1 wt%
-------------------------------------	----------------------------

Phoenix Contact 2025 © - all rights reserved
<https://www.phoenixcontact.com>

PHOENIX CONTACT Ltd
Halesfield 13, Telford
Shropshire, TF7 4PG
01952 681700
info@phoenixcontact.co.uk