







Accessory 3WA/3WL Undervoltage release (UVR) Instantaneous (0,08 s) and short-delay (0,2 s), 110-127 V AC / 110-125 V DC,

Model	
product brand name	SENTRON
product designation	Undervoltage release
design of the product	undervoltage release (UVR), instantaneous (0.08 s) and short-time delayed (0.2 s), 110 to 127 V AC / 110 to 125 V DC
design of the fuse link	fuse gG: 2 A, miniature circuit breaker C characteristic: 4 A, miniature circuit breaker D characteristic: 2 A
closing apparent power [VA]	60 VA
operating apparent power [VA]	5 VA
closing active power [W]	50 W
operating active power [W]	5 W
OFF-delay time minimum	80 ms
OFF-delay time maximum	200 ms
control supply voltage (Us) at AC rated value	110 to 127 V 50/60 Hz
Net Weight	709 g
ambient temperature during operation	
• minimum	-40 °C
• maximum	70 °C
ambient temperature during storage	
• minimum	-40 °C
• maximum	80 °C

Approvals Certificates

General Product Approval	EMV	Test Certificates
    		Miscellaneous

Test Certificates	Maritime application	other	Dangerous goods
Special Test Certificate			Dangerous goods information

Further information

Information on the packaging
<https://support.industry.siemens.com/cs/ww/en/view/109813875>
 Information- and Downloadcenter (Catalogs, Brochures,...)
<http://www.siemens.com/lowvoltage/catalogs>

Industry Mall (Online ordering system)

<https://mall.industry.siemens.com/mall/en/en/Catalog/product?mlfb=3WA9111-0AE05>

Service&Support (Manuals, Certificates, Characteristics, FAQs,...)

<https://support.industry.siemens.com/cs/ww/en/ps/3WA9111-0AE05>

Image database (product images, 2D dimension drawings, 3D models, device circuit diagrams, ...)

http://www.automation.siemens.com/bilddb/cax_en.aspx?mlfb=3WA9111-0AE05

CAX-Online-Generator

<http://www.siemens.com/cax>

Tender specifications

<http://www.siemens.com/specifications>

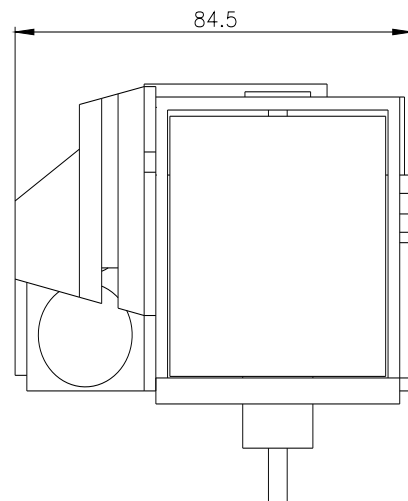
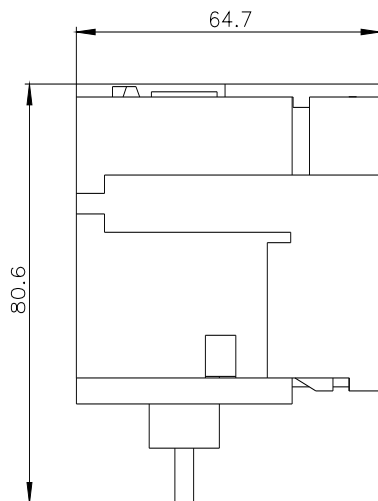

last modified:

4/4/2025 

