

S2C 2.5**Weidmüller Interface GmbH & Co. KG**

Klingenbergstraße 26

D-32758 Detmold

Germany

www.weidmueller.com

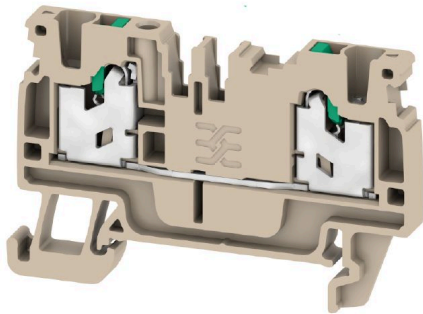

To feed through power, signal, and data is the classical requirement in electrical engineering and panel building. The insulating material, the connection system and the design of the terminal blocks are the differentiating features. A feed-through terminal block is suitable for joining and/or connecting one or more conductors. They could have one or more connection levels that are on the same potential or insulated against one another.

General ordering data

Version	Feed-through terminal block, SNAP IN, dark beige, 2.5 mm ² , 24 A, 800 V, Number of connections: 2
Order No.	2674530000
Type	S2C 2.5
GTIN (EAN)	4064675266389
Qty.	100 ST

S2C 2.5

Weidmüller Interface GmbH & Co. KG
Klingenbergstraße 26
D-32758 Detmold
Germany

www.weidmueller.com

Technical data

Approvals

Approvals



ROHS	Conform
UL File Number Search	UL Website
Certificate No. (cURus)	E60693

Dimensions and weights

Depth	38 mm	Depth (inches)	1.4961 inch
Height	59 mm	Height (inches)	2.3228 inch
Width	5.1 mm	Width (inches)	0.2008 inch
Net weight	8.45 g		

Temperatures

Storage temperature	-25 °C...55 °C	Ambient temperature	-5 °C
Continuous operating temp., min.	-60 °C	Continuous operating temp., max.	130 °C

Environmental Product Compliance

RoHS Compliance Status	Compliant without exemption
REACH SVHC	No SVHC above 0.1 wt%

Material data

Material	Wemid	Colour	dark beige
Colour of operational elements	green	UL 94 flammability rating	V-0

Rating data IECEx/ATEX

Certificate No. (ATEX)	TUEV22ATEX8925U	Certificate No. (IECEx)	IECExTUR22.0073U
Max. voltage (ATEX)	550 V	Current (ATEX)	21 A
Wire cross section max. (ATEX)	2.5 mm ²		

System specifications

End cover plate required	Yes	Number of potentials	1
Number of levels	1	Number of clamping points per level	2
Number of potentials per tier	1	Levels cross-connected internally	No
PE connection	No	Rail	TS 35
N-function	No	PE function	No
PEN function	No		

Additional technical data

With snap-in pegs	No	Open sides	right
Snap-on	Yes	Type of fixing	Snap-on
Explosion-tested version	No	Type of mounting	TS 35

S2C 2.5

Weidmüller Interface GmbH & Co. KG

Klingenbergstraße 26

D-32758 Detmold

Germany

www.weidmueller.com

Technical data

CSA rating data

Wire cross section max. (CSA)	14 AWG	Voltage size C (CSA)	600 V
Current size C (CSA)	15 A	Certificate No. (CSA)	200039-8116541
Voltage size B (CSA)	600 V	Current size B (CSA)	15 A
Voltage size D (CSA)	600 V	Current size D (CSA)	5 A
Wire cross section min. (CSA)	20 AWG		

Conductors for clamping (additional connection)

Connection type, additional connection SNAP IN

Conductors for clamping (rated connection)

Gauge to IEC 60947-1	A2	Wire connection cross section AWG, max.	AWG 14
Connection direction	top	Stripping length	10 mm
Type of connection	SNAP IN	Number of connections	2
Clamping range, max.	2.5 mm ²	Clamping range, min.	0.34 mm ²
Blade size	0.6 x 3.5 mm	Wire connection cross section AWG, min.	AWG 22
Wire connection cross-section, finely stranded with wire-end ferrules DIN 46228/4, max.	2.5 mm ²	Wire connection cross-section, finely stranded with wire-end ferrules DIN 46228/4, min.	0.34 mm ²
Wire connection cross-section, finely stranded with wire-end ferrules DIN 46228/1, max.	2.5 mm ²	Wire connection cross-section, finely stranded with wire-end ferrules DIN 46228/1, min.	0.34 mm ²
Wire connection cross section, finely stranded, max.	2.5 mm ²	Wire connection cross section, finely stranded, min.	0.5 mm ²
Connection cross-section, stranded, max.	2.5 mm ²	Connection cross-section, stranded, min.	0.5 mm ²
Twin wire-end ferrules, max.	0.75 mm ²	Twin wire-end ferrules, min.	0.5 mm ²
Wire connection cross-section, solid core, max.	2.5 mm ²	Wire connection cross-section, solid core, min.	0.5 mm ²
Connection cross-section, finely stranded, max.	2.5 mm ²	Connection cross-section, finely stranded, min.	0.34 mm ²

General

Wire connection cross section AWG, max.	AWG 14	Wire connection cross section AWG, min.	AWG 22
Standards	IEC 60947-7-1	Rail	TS 35

Rating data

Rated cross-section	2.5 mm ²	Rated voltage	800 V
Rated DC voltage	800 V	Rated current	24 A
Current at maximum wires	24 A	Standards	IEC 60947-7-1
Volume resistance according to IEC 60947-7-x	1.33 mΩ	Rated impulse withstand voltage	8 kV
Power loss in accordance with IEC 60947-7-x	0.77 mW	Surge voltage category	III
Pollution severity	3		

UL rating data

Conductor size Factory wiring max. (cURus)	12 AWG	Voltage size B (cURus)	600 V
Voltage size D (cURus)	600 V	Certificate No. (cURus)	E60693

S2C 2.5

Weidmüller Interface GmbH & Co. KG

Klingenbergstraße 26
D-32758 Detmold
Germany

www.weidmueller.com

Technical data

Conductor size Field wiring min. (cURus)	22 AWG	Conductor size Factory wiring min. (cURus)	22 AWG
Current size B (cURus)	20 A	Voltage size C (cURus)	600 V
Current size C (cURus)	20 A	Current size D (cURus)	5 A
Conductor size Field wiring max. (cURus)	12 AWG		

Classifications

ETIM 6.0	EC000897	ETIM 7.0	EC000897
ETIM 8.0	EC000897	ETIM 9.0	EC000897
ETIM 10.0	EC000897	ECLASS 9.0	27-14-11-20
ECLASS 9.1	27-14-11-20	ECLASS 10.0	27-14-11-20
ECLASS 11.0	27-14-11-20	ECLASS 12.0	27-14-11-20
ECLASS 13.0	27-25-01-01	ECLASS 14.0	27-25-01-01
ECLASS 15.0	27-25-01-01		

Drawings

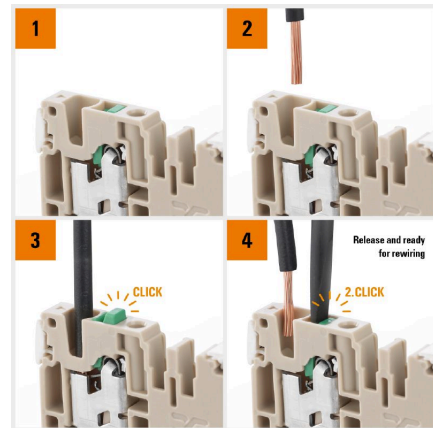
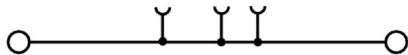

S2C 2.5

Weidmüller Interface GmbH & Co. KG

Klingenbergstraße 26

D-32758 Detmold

Germany

www.weidmueller.com

Accessories

A-Series



Weidmüller's range of products includes end brackets that guarantee a permanent, reliable mounting on the terminal rail and prevent sliding. Versions with and without screws are available. The end brackets include marking options, also for group markers, and also a test plug holder.

General ordering data

Type	AEB 35 SC/1	Version
Order No.	1991920000	A-series, End bracket
GTIN (EAN)	4050118376722	
Qty.	50 ST	
Type	ATPG 2.5 MI-R	Version
Order No.	1991960000	Test adapter (terminal), 1.5 mm ² , 250 V, 0.2 A
GTIN (EAN)	4050118376685	
Qty.	50 ST	
Type	ATPG 2.5/3	Version
Order No.	2041190000	Test adapter (terminal), 1.5 mm ² , 250 V, 0.2 A
GTIN (EAN)	4050118409604	
Qty.	25 ST	
Type	ATPG 2.5/5	Version
Order No.	2041180000	Test adapter (terminal), 1.5 mm ² , 250 V, 0.2 A
GTIN (EAN)	4050118409505	
Qty.	25 ST	
Type	ATPG 1.5-10 L	Version
Order No.	1991890000	Test adapter (terminal), 1.5 mm ² , 250 V, 0.2 A
GTIN (EAN)	4050118376647	
Qty.	50 ST	

2.5 mm²

The plug-in cross-connections feature easy handling and quick installation. This saves a great deal of time during installation in comparison with screwed solutions.

General ordering data

Type	ZQV 2.5N/10	Version
Order No.	1527690000	Cross-connector (terminal), Plugged, orange, 24 A, Number of poles:
GTIN (EAN)	4050118447989	10, Pitch in mm (P): 5.10, Insulated: Yes, Width: 48.7 mm
Qty.	20 ST	

S2C 2.5

Weidmüller Interface GmbH & Co. KG

Klingenbergstraße 26
D-32758 Detmold
Germany

www.weidmueller.com

Accessories

Type	ZQV 2.5N/10 BL	Version
Order No.	1527880000	Cross-connector (terminal), Plugged, blue, 24 A, Number of poles: 10,
GTIN (EAN)	4050118448573	Pitch in mm (P): 5.10, Insulated: Yes, Width: 48.7 mm
Qty.	20 ST	
Type	ZQV 2.5N/10 RD	Version
Order No.	2108910000	Cross-connector (terminal), Plugged, red, 24 A, Number of poles: 10,
GTIN (EAN)	4050118486018	Pitch in mm (P): 5.10, Insulated: Yes, Width: 48.7 mm
Qty.	20 ST	
Type	ZQV 2.5N/2	Version
Order No.	1527540000	Cross-connector (terminal), Plugged, orange, 24 A, Number of poles:
GTIN (EAN)	4050118448467	2, Pitch in mm (P): 5.10, Insulated: Yes, Width: 7.9 mm
Qty.	60 ST	
Type	ZQV 2.5N/2 BL	Version
Order No.	1527740000	Cross-connector (terminal), Plugged, blue, 24 A, Number of poles: 2,
GTIN (EAN)	4050118448658	Pitch in mm (P): 5.10, Insulated: Yes, Width: 7.9 mm
Qty.	60 ST	
Type	ZQV 2.5N/2 RD	Version
Order No.	2108470000	Cross-connector (terminal), Plugged, red, 24 A, Number of poles: 2,
GTIN (EAN)	4050118448542	Pitch in mm (P): 5.10, Insulated: Yes, Width: 7.9 mm
Qty.	60 ST	
Type	ZQV 2.5N/20	Version
Order No.	1527720000	Cross-connector (terminal), Plugged, orange, 24 A, Number of poles:
GTIN (EAN)	4050118447972	20, Pitch in mm (P): 5.10, Insulated: Yes, Width: 102 mm
Qty.	20 ST	
Type	ZQV 2.5N/20 BL	Version
Order No.	1527890000	Cross-connector (terminal), Plugged, blue, 24 A, Number of poles: 20,
GTIN (EAN)	4050118448566	Pitch in mm (P): 5.10, Insulated: Yes, Width: 102 mm
Qty.	20 ST	
Type	ZQV 2.5N/20 RD	Version
Order No.	2108920000	Cross-connector (terminal), Plugged, red, 24 A, Number of poles: 20,
GTIN (EAN)	4050118485899	Pitch in mm (P): 5.10, Insulated: Yes, Width: 102 mm
Qty.	20 ST	
Type	ZQV 2.5N/3	Version
Order No.	1527570000	Cross-connector (terminal), Plugged, orange, 24 A, Number of poles:
GTIN (EAN)	4050118448450	3, Pitch in mm (P): 5.10, Insulated: Yes, Width: 13 mm
Qty.	60 ST	
Type	ZQV 2.5N/3 BL	Version
Order No.	1527770000	Cross-connector (terminal), Plugged, blue, 24 A, Number of poles: 3,
GTIN (EAN)	4050118448641	Pitch in mm (P): 5.10, Insulated: Yes, Width: 13 mm
Qty.	60 ST	
Type	ZQV 2.5N/3 RD	Version
Order No.	2108690000	Cross-connector (terminal), Plugged, red, 24 A, Number of poles: 3,
GTIN (EAN)	4050118448535	Pitch in mm (P): 5.10, Insulated: Yes, Width: 13 mm
Qty.	60 ST	
Type	ZQV 2.5N/4	Version
Order No.	1527590000	Cross-connector (terminal), Plugged, orange, 24 A, Number of poles:
GTIN (EAN)	4050118448443	4, Pitch in mm (P): 5.10, Insulated: Yes, Width: 18.1 mm
Qty.	60 ST	
Type	ZQV 2.5N/4 BL	Version
Order No.	1527780000	Cross-connector (terminal), Plugged, blue, 24 A, Number of poles: 4,
GTIN (EAN)	4050118448634	Pitch in mm (P): 5.10, Insulated: Yes, Width: 18.1 mm
Qty.	60 ST	

S2C 2.5

Weidmüller Interface GmbH & Co. KG

Klingenbergstraße 26
D-32758 Detmold
Germany

www.weidmueller.com

Accessories

Type	ZQV 2.5N/4 RD	Version
Order No.	2108700000	Cross-connector (terminal), Plugged, red, 24 A, Number of poles: 4,
GTIN (EAN)	4050118448528	Pitch in mm (P): 5.10, Insulated: Yes, Width: 18.1 mm
Qty.	60 ST	
Type	ZQV 2.5N/5	Version
Order No.	1527620000	Cross-connector (terminal), Plugged, orange, 24 A, Number of poles: 5,
GTIN (EAN)	4050118448436	Pitch in mm (P): 5.10, Insulated: Yes, Width: 23.2 mm
Qty.	20 ST	
Type	ZQV 2.5N/5 BL	Version
Order No.	1527790000	Cross-connector (terminal), Plugged, blue, 24 A, Number of poles: 5,
GTIN (EAN)	4050118448627	Pitch in mm (P): 5.10, Insulated: Yes, Width: 23.2 mm
Qty.	20 ST	
Type	ZQV 2.5N/5 RD	Version
Order No.	2108710000	Cross-connector (terminal), Plugged, red, 24 A, Number of poles: 5,
GTIN (EAN)	4050118448511	Pitch in mm (P): 5.10, Insulated: Yes, Width: 23.2 mm
Qty.	20 ST	
Type	ZQV 2.5N/50	Version
Order No.	1527730000	Cross-connector (terminal), Plugged, orange, 24 A, Number of poles: 50,
GTIN (EAN)	4050118411362	Pitch in mm (P): 5.10, Insulated: Yes, Width: 255 mm
Qty.	5 ST	
Type	ZQV 2.5N/50 BL	Version
Order No.	1527920000	Cross-connector (terminal), Plugged, blue, 24 A, Number of poles: 50,
GTIN (EAN)	4050118448559	Pitch in mm (P): 5.10, Insulated: Yes, Width: 255 mm
Qty.	5 ST	
Type	ZQV 2.5N/50 RD	Version
Order No.	2109000000	Cross-connector (terminal), Plugged, red, 24 A, Number of poles: 50,
GTIN (EAN)	4050118486001	Pitch in mm (P): 5.10, Insulated: Yes, Width: 255 mm
Qty.	5 ST	
Type	ZQV 2.5N/6	Version
Order No.	1527630000	Cross-connector (terminal), Plugged, orange, 24 A, Number of poles: 6,
GTIN (EAN)	4050118448429	Pitch in mm (P): 5.10, Insulated: Yes, Width: 28.3 mm
Qty.	20 ST	
Type	ZQV 2.5N/6 BL	Version
Order No.	1527820000	Cross-connector (terminal), Plugged, blue, 24 A, Number of poles: 6,
GTIN (EAN)	4050118448610	Pitch in mm (P): 5.10, Insulated: Yes, Width: 28.3 mm
Qty.	20 ST	
Type	ZQV 2.5N/6 RD	Version
Order No.	2108720000	Cross-connector (terminal), Plugged, red, 24 A, Number of poles: 6,
GTIN (EAN)	4050118448504	Pitch in mm (P): 5.10, Insulated: Yes, Width: 28.3 mm
Qty.	20 ST	
Type	ZQV 2.5N/7	Version
Order No.	1527640000	Cross-connector (terminal), Plugged, orange, 24 A, Number of poles: 7,
GTIN (EAN)	4050118448412	Pitch in mm (P): 5.10, Insulated: Yes, Width: 33.4 mm
Qty.	20 ST	
Type	ZQV 2.5N/7 BL	Version
Order No.	1527830000	Cross-connector (terminal), Plugged, blue, 24 A, Number of poles: 7,
GTIN (EAN)	4050118448603	Pitch in mm (P): 5.10, Insulated: Yes, Width: 33.4 mm
Qty.	20 ST	
Type	ZQV 2.5N/7 RD	Version
Order No.	2108810000	Cross-connector (terminal), Plugged, red, 24 A, Number of poles: 7,
GTIN (EAN)	4050118448498	Pitch in mm (P): 5.10, Insulated: Yes, Width: 33.4 mm
Qty.	20 ST	

S2C 2.5

Weidmüller Interface GmbH & Co. KG

Klingenbergstraße 26
D-32758 Detmold
Germany

www.weidmueller.com

Accessories

Type	ZQV 2.5N/8	Version
Order No.	1527670000	Cross-connector (terminal), Plugged, orange, 24 A, Number of poles:
GTIN (EAN)	4050118448405	8, Pitch in mm (P): 5.10, Insulated: Yes, Width: 38.5 mm
Qty.	20 ST	
Type	ZQV 2.5N/8 BL	Version
Order No.	1527840000	Cross-connector (terminal), Plugged, blue, 24 A, Number of poles: 8,
GTIN (EAN)	4050118448597	Pitch in mm (P): 5.10, Insulated: Yes, Width: 38.5 mm
Qty.	20 ST	
Type	ZQV 2.5N/8 RD	Version
Order No.	2108870000	Cross-connector (terminal), Plugged, red, 24 A, Number of poles: 8,
GTIN (EAN)	4050118448481	Pitch in mm (P): 5.10, Insulated: Yes, Width: 38.5 mm
Qty.	20 ST	
Type	ZQV 2.5N/9	Version
Order No.	1527680000	Cross-connector (terminal), Plugged, orange, 24 A, Number of poles:
GTIN (EAN)	4050118447996	9, Pitch in mm (P): 5.10, Insulated: Yes, Width: 43.6 mm
Qty.	20 ST	
Type	ZQV 2.5N/9 BL	Version
Order No.	1527870000	Cross-connector (terminal), Plugged, blue, 24 A, Number of poles: 9,
GTIN (EAN)	4050118448580	Pitch in mm (P): 5.10, Insulated: Yes, Width: 43.6 mm
Qty.	20 ST	
Type	ZQV 2.5N/9 RD	Version
Order No.	2108900000	Cross-connector (terminal), Plugged, red, 24 A, Number of poles: 9,
GTIN (EAN)	4050118448474	Pitch in mm (P): 5.10, Insulated: Yes, Width: 43.6 mm
Qty.	20 ST	

Blank



The Dekafix (DEK) marker is the universal marker for all conductor and plug-in connectors as well as for electronic sub-assemblies. The system is ideal for short number sequences and covers a wide range of ready-printed markers.

Strips for fast installation in only one work step. The printing is easy to read, rich in contrast and available in various widths.

- Large range of ready-to-use markers
- Strips for fast installation
- Terminal markers, suitable for all Weidmüller cable connectors
- Available as blank MultiCard or with standard printing

For custom printing: Please send us a file of our labeling software M-Print PRO or M-Print PRO Online (without installation) for your labeling specifications.

General ordering data

Type	DEK 5/5 MC NE BR	Version
Order No.	1249870000	Dekafix, Terminal marker, 5 x 5 mm, Pitch in mm (P): 5.00
GTIN (EAN)	4050118051865	Weidmueller, brown
Qty.	1000 ST	

S2C 2.5

Weidmüller Interface GmbH & Co. KG

Klingenbergstraße 26

D-32758 Detmold

Germany

Accessories

www.weidmueller.com

V0



The Dekafix (DEK) marker is the universal marker for all conductor and plug-in connectors as well as for electronic sub-assemblies. The system is ideal for short number sequences and covers a wide range of ready-printed markers.

Strips for fast installation in only one work step. The printing is easy to read, rich in contrast and available in various widths.

- Large range of ready-to-use markers
 - Strips for fast installation
 - Terminal markers, suitable for all Weidmüller cable connectors
 - Available as blank MultiCard or with standard printing
- For custom printing: Please send us a file of our labeling software M-Print PRO or M-Print PRO Online (without installation) for your labeling specifications.

General ordering data

Type	DEK 5/5 MC NE V0 WS	Version	
Order No.	1388530000		Dekafix, Terminal marker, 5 x 5 mm, Pitch in mm (P): 5.00
GTIN (EAN)	4050118188622		Weidmueller, white
Qty.	1000 ST		

Blank



The Dekafix (DEK) marker is the universal marker for all conductor and plug-in connectors as well as for electronic sub-assemblies. The system is ideal for short number sequences and covers a wide range of ready-printed markers.

Strips for fast installation in only one work step. The printing is easy to read, rich in contrast and available in various widths.

- Large range of ready-to-use markers
 - Strips for fast installation
 - Terminal markers, suitable for all Weidmüller cable connectors
 - Available as blank MultiCard or with standard printing
- For custom printing: Please send us a file of our labeling software M-Print PRO or M-Print PRO Online (without installation) for your labeling specifications.

General ordering data

Type	DEK 5/5 MC NE VI	Version	
Order No.	1249860000		Dekafix, Terminal marker, 5 x 5 mm, Pitch in mm (P): 5.00
GTIN (EAN)	4050118042764		Weidmueller, violet
Qty.	1000 ST		

S2C 2.5

Weidmüller Interface GmbH & Co. KG
 Klingenbergstraße 26
 D-32758 Detmold
 Germany

www.weidmueller.com

Accessories

Custom printing



The Dekafix (DEK) marker is the universal marker for all conductor and plug-in connectors as well as for electronic sub-assemblies. The system is ideal for short number sequences and covers a wide range of ready-printed markers.

Strips for fast installation in only one work step. The printing is easy to read, rich in contrast and available in various widths.

- Large range of ready-to-use markers
 - Strips for fast installation
 - Terminal markers, suitable for all Weidmüller cable connectors
 - Available as blank MultiCard or with standard printing
- For custom printing: Please send us a file of our labeling software M-Print PRO or M-Print PRO Online (without installation) for your labeling specifications.

General ordering data

Type	DEK 5/5 MC SDR	Version
Order No.	1609810000	Dekafix, Terminal marker, 5 x 5 mm, Pitch in mm (P): 5.00
GTIN (EAN)	4008190456597	Weidmueller, To customer specification
Qty.	200 ST	

Blank



The Dekafix (DEK) marker is the universal marker for all conductor and plug-in connectors as well as for electronic sub-assemblies. The system is ideal for short number sequences and covers a wide range of ready-printed markers.

Strips for fast installation in only one work step. The printing is easy to read, rich in contrast and available in various widths.

- Large range of ready-to-use markers
 - Strips for fast installation
 - Terminal markers, suitable for all Weidmüller cable connectors
 - Available as blank MultiCard or with standard printing
- For custom printing: Please send us a file of our labeling software M-Print PRO or M-Print PRO Online (without installation) for your labeling specifications.

General ordering data

Type	DEK 5/5 MC NE BL	Version
Order No.	1609801693	Dekafix, Terminal marker, 5 x 5 mm, Pitch in mm (P): 5.00
GTIN (EAN)	4008190397166	Weidmueller, blue
Qty.	1000 ST	
Type	DEK 5/5 MC NE GE	Version
Order No.	1609801687	Dekafix, Terminal marker, 5 x 5 mm, Pitch in mm (P): 5.00
GTIN (EAN)	4008190397135	Weidmueller, yellow
Qty.	1000 ST	

S2C 2.5

Weidmüller Interface GmbH & Co. KG

Klingenbergstraße 26
D-32758 Detmold
Germany

www.weidmueller.com

Accessories

Type	DEK 5/5 MC NE GN	Version
Order No.	1609801688	Dekafix, Terminal marker, 5 x 5 mm, Pitch in mm (P): 5.00
GTIN (EAN)	4008190397142	Weidmueller, green
Qty.	1000 ST	
Type	DEK 5/5 MC NE GR	Version
Order No.	1609801691	Dekafix, Terminal marker, 5 x 5 mm, Pitch in mm (P): 5.00
GTIN (EAN)	4008190397159	Weidmueller, grey
Qty.	1000 ST	
Type	DEK 5/5 MC NE OR	Version
Order No.	1238340000	Dekafix, Terminal marker, 5 x 5 mm, Pitch in mm (P): 5.00
GTIN (EAN)	4050118062632	Weidmueller, orange
Qty.	1000 ST	
Type	DEK 5/5 MC NE RT	Version
Order No.	1609801686	Dekafix, Terminal marker, 5 x 5 mm, Pitch in mm (P): 5.00
GTIN (EAN)	4008190397128	Weidmueller, red
Qty.	1000 ST	
Type	DEK 5/5 MC NE SW	Version
Order No.	1457550000	Dekafix, Terminal marker, 5 x 5 mm, Pitch in mm (P): 5.00
GTIN (EAN)	4050118263817	Weidmueller, black
Qty.	1000 ST	
Type	DEK 5/5 MC NE WS	Version
Order No.	1609801044	Dekafix, Terminal marker, 5 x 5 mm, Pitch in mm (P): 5.00
GTIN (EAN)	4008190397111	Weidmueller, white
Qty.	1000 ST	

Plus

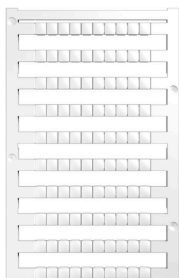

The Dekafix (DEK) marker is the universal marker for all conductor and plug-in connectors as well as for electronic sub-assemblies. The system is ideal for short number sequences and covers a wide range of ready-printed markers.

Strips for fast installation in only one work step. The printing is easy to read, rich in contrast and available in various widths.

- Large range of ready-to-use markers
 - Strips for fast installation
 - Terminal markers, suitable for all Weidmüller cable connectors
 - Available as blank MultiCard or with standard printing
- For custom printing: Please send us a file of our labeling software M-Print PRO or M-Print PRO Online (without installation) for your labeling specifications.

General ordering data

Type	DEK 5/5 PLUS MC NE GE	Version
Order No.	1907520000	Dekafix, Terminal marker, 5 x 5 mm, Pitch in mm (P): 5.00
GTIN (EAN)	4032248532100	Weidmueller, yellow
Qty.	1000 ST	
Type	DEK 5/5 PLUS MC NE WS	Version
Order No.	1854490000	Dekafix, Terminal marker, 5 x 5 mm, Pitch in mm (P): 5.00
GTIN (EAN)	4032248393596	Weidmueller, white
Qty.	1000 ST	

S2C 2.5

Weidmüller Interface GmbH & Co. KG
 Klingenbergstraße 26
 D-32758 Detmold
 Germany

www.weidmueller.com

Accessories

Custom printing



The Dekafix (DEK) marker is the universal marker for all conductor and plug-in connectors as well as for electronic sub-assemblies. The system is ideal for short number sequences and covers a wide range of ready-printed markers.

Strips for fast installation in only one work step. The printing is easy to read, rich in contrast and available in various widths.

- Large range of ready-to-use markers
 - Strips for fast installation
 - Terminal markers, suitable for all Weidmüller cable connectors
 - Available as blank MultiCard or with standard printing
- For custom printing: Please send us a file of our labeling software M-Print PRO or M-Print PRO Online (without installation) for your labeling specifications.

General ordering data

Type	DEK 5/5 PLUS MC SDR	Version	
Order No.	1854500000		Dekafix, Terminal marker, 5 x 5 mm, Pitch in mm (P): 5.00
GTIN (EAN)	4032248393602		Weidmueller, To customer specification
Qty.	200 ST		

Blank



The Dekafix (DEK) marker is the universal marker for all conductor and plug-in connectors as well as for electronic sub-assemblies. The system is ideal for short number sequences and covers a wide range of ready-printed markers.

Strips for fast installation in only one work step. The printing is easy to read, rich in contrast and available in various widths.

- Large range of ready-to-use markers
 - Strips for fast installation
 - Terminal markers, suitable for all Weidmüller cable connectors
 - Available as blank MultiCard or with standard printing
- For custom printing: Please send us a file of our labeling software M-Print PRO or M-Print PRO Online (without installation) for your labeling specifications.

General ordering data

Type	DEK 5/5 S MC NE WS	Version	
Order No.	1341620000		Dekafix, Terminal marker, 5 x 5 mm, Pitch in mm (P): 5.00
GTIN (EAN)	4050118145793		Weidmueller, white
Qty.	400 ST		

S2C 2.5

Weidmüller Interface GmbH & Co. KG

Klingenbergstraße 26

D-32758 Detmold

Germany

www.weidmueller.com

Accessories

Custom printing



The Dekafix (DEK) marker is the universal marker for all conductor and plug-in connectors as well as for electronic sub-assemblies. The system is ideal for short number sequences and covers a wide range of ready-printed markers.

Strips for fast installation in only one work step. The printing is easy to read, rich in contrast and available in various widths.

- Large range of ready-to-use markers
 - Strips for fast installation
 - Terminal markers, suitable for all Weidmüller cable connectors
 - Available as blank MultiCard or with standard printing
- For custom printing: Please send us a file of our labeling software M-Print PRO or M-Print PRO Online (without installation) for your labeling specifications.

General ordering data

Type	DEK 5/5 S MC SDR	Version
Order No.	1341590000	Dekafix, Terminal marker, 5 x 5 mm, Pitch in mm (P): 5.00
GTIN (EAN)	4050118146042	Weidmueller, To customer specification
Qty.	80 ST	
Type	WS 10/5 M PLUS MC SDR	Version
Order No.	2007770000	WS, Terminal marker, 10 x 5 mm, Pitch in mm (P): 5.00 Weidmueller,
GTIN (EAN)	4050118393279	Allen-Bradley, To customer specification
Qty.	120 ST	

Blank



WS markers are the perfect match for the W-series connectors. Thanks to their system compatibility, the WS tags can also be used with the I-series and the Z-series. The large marking surfaces do not only permit long character strings but also multi-line text. WS markers are ideal for labels with long, customised character strings. Thanks to the proven MultiCard format, printing with PrintJet CONNECT oder/or Plotter is possible.

- Can be fitted in strips or individually
 - Markers in proven MultiCard format
- For custom printing: Please send us a file of our labeling software M-Print PRO or M-Print PRO Online (without installation) for your labeling specifications.

General ordering data

Type	WS 10/5 M PLUS MC NE WS	Version
Order No.	2003770000	WS, Terminal marker, 10 x 5 mm, Pitch in mm (P): 5.00 Weidmueller,
GTIN (EAN)	4050118424447	Allen-Bradley, white
Qty.	600 ST	
Type	WS 10/5 M MC NE WS	Version
Order No.	1792000000	WS, Terminal marker, 10 x 5 mm, Pitch in mm (P): 5.00 Weidmueller,
GTIN (EAN)	4032248223862	Allen-Bradley, white
Qty.	720 ST	

S2C 2.5

Weidmüller Interface GmbH & Co. KG
 Klingenbergstraße 26
 D-32758 Detmold
 Germany

www.weidmueller.com

Accessories

Custom printing

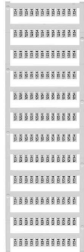

WS markers are the perfect match for the W-series connectors. Thanks to their system compatibility, the WS tags can also be used with the I-series and the Z-series. The large marking surfaces do not only permit long character strings but also multi-line text. WS markers are ideal for labels with long, customised character strings. Thanks to the proven MultiCard format, printing with PrintJet CONNECT oder/or Plotter is possible.

- Can be fitted in strips or individually
- Markers in proven MultiCard format

For custom printing: Please send us a file of our labeling software M-Print PRO or M-Print PRO Online (without installation) for your labeling specifications.

General ordering data

Type	WS 10/5 MC M SDR	Version
Order No.	1792010000	WS, Terminal marker, 10 x 5 mm, Pitch in mm (P): 5.00 Weidmueller,
GTIN (EAN)	4032248223879	Allen-Bradley, To customer specification
Qty.	144 ST	

Blank



WS markers are the perfect match for the W-series connectors. Thanks to their system compatibility, the WS tags can also be used with the I-series and the Z-series. The large marking surfaces do not only permit long character strings but also multi-line text. WS markers are ideal for labels with long, customised character strings. Thanks to the proven MultiCard format, printing with PrintJet CONNECT oder/or Plotter is possible.

- Can be fitted in strips or individually
- Markers in proven MultiCard format

For custom printing: Please send us a file of our labeling software M-Print PRO or M-Print PRO Online (without installation) for your labeling specifications.

General ordering data

Type	WS 10/5 MC NE BL	Version
Order No.	1773531693	WS, Terminal marker, 10 x 5 mm, Pitch in mm (P): 5.00 Weidmueller,
GTIN (EAN)	4032248141814	Allen-Bradley, blue
Qty.	720 ST	
Type	WS 10/5 MC NE GE	Version
Order No.	1773531687	WS, Terminal marker, 10 x 5 mm, Pitch in mm (P): 5.00 Weidmueller,
GTIN (EAN)	4032248141753	Allen-Bradley, yellow
Qty.	720 ST	
Type	WS 10/5 MC NE RT	Version
Order No.	1773531686	WS, Terminal marker, 10 x 5 mm, Pitch in mm (P): 5.00 Weidmueller,
GTIN (EAN)	4032248141746	Allen-Bradley, red
Qty.	720 ST	

S2C 2.5

Weidmüller Interface GmbH & Co. KG

Klingenbergstraße 26
D-32758 Detmold
Germany

www.weidmueller.com

Accessories

Type	WS 10/5 MC NE WS	Version
Order No.	1635000000	WS, Terminal marker, 10 x 5 mm, Pitch in mm (P): 5.00 Weidmueller,
GTIN (EAN)	4008190261948	Allen-Bradley, white
Qty.	720 ST	

Custom printing



WS markers are the perfect match for the W-series connectors. Thanks to their system compatibility, the WS tags can also be used with the I-series and the Z-series. The large marking surfaces do not only permit long character strings but also multi-line text. WS markers are ideal for labels with long, customised character strings. Thanks to the proven MultiCard format, printing with PrintJet CONNECT oder/or Plotter is possible.

- Can be fitted in strips or individually
- Markers in proven MultiCard format

For custom printing: Please send us a file of our labeling software M-Print PRO or M-Print PRO Online (without installation) for your labeling specifications.

General ordering data

Type	WS 10/5 MC SDR	Version
Order No.	1635010000	WS, Terminal marker, 10 x 5 mm, Pitch in mm (P): 5.00 Weidmueller,
GTIN (EAN)	4008190456634	Allen-Bradley, To customer specification
Qty.	144 ST	

Blank



WS markers are the perfect match for the W-series connectors. Thanks to their system compatibility, the WS tags can also be used with the I-series and the Z-series. The large marking surfaces do not only permit long character strings but also multi-line text. WS markers are ideal for labels with long, customised character strings. Thanks to the proven MultiCard format, printing with PrintJet CONNECT oder/or Plotter is possible.

- Can be fitted in strips or individually
- Markers in proven MultiCard format

For custom printing: Please send us a file of our labeling software M-Print PRO or M-Print PRO Online (without installation) for your labeling specifications.

General ordering data

Type	WS 10/5 PLUS MC NE WS	Version
Order No.	1046380000	WS, Terminal marker, 10 x 5 mm, Pitch in mm (P): 5.00 Weidmueller,
GTIN (EAN)	4032248782086	Allen-Bradley, white
Qty.	600 ST	

S2C 2.5

Weidmüller Interface GmbH & Co. KG

Klingenbergstraße 26

D-32758 Detmold

Germany

www.weidmueller.com

Accessories

Custom printing

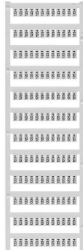

WS markers are the perfect match for the W-series connectors. Thanks to their system compatibility, the WS tags can also be used with the I-series and the Z-series. The large marking surfaces do not only permit long character strings but also multi-line text. WS markers are ideal for labels with long, customised character strings. Thanks to the proven MultiCard format, printing with PrintJet CONNECT oder/or Plotter is possible.

- Can be fitted in strips or individually
- Markers in proven MultiCard format

For custom printing: Please send us a file of our labeling software M-Print PRO or M-Print PRO Online (without installation) for your labeling specifications.

General ordering data

Type	WS 10/5 PLUS MC SDR	Version	
Order No.	1046320000	WS, Terminal marker, 10 x 5 mm, Pitch in mm (P): 5.00 Weidmueller,	
GTIN (EAN)	4032248782024	Allen-Bradley, To customer specification	
Qty.	120 ST		

DEK 5/5



WS/ DEK

MultiMark terminal markers use an innovative composite material made from two components. The hard base contour of the marker snaps securely into the connector. The elastic surface finish makes the marker easy to mount. This specially punched material enables the strips to be stretched to accommodate the slight variations in spacing that tend to add up, especially with long terminal blocks. Another advantage: the excellent printability of the surface material guarantees durable and wear-resistant labelling. A print resolution of 300 dpi also produces a very legible script.

Your benefits with MultiMark

- Firm hold and durable printing
- Continuous strips save installation time
- Easy mounting thanks to an innovative composite material
- Large label field for optimal legibility
- High flexibility thanks to manufacturer independence

General ordering data

Type	DEK 5/5 MM WS	Version	
Order No.	2007110000	Dekafix, Terminal marker, 5 x 5 mm, Weidmueller, white	
GTIN (EAN)	4050118391862		
Qty.	800 ST		

S2C 2.5

Weidmüller Interface GmbH & Co. KG

Klingenbergstraße 26

D-32758 Detmold

Germany

www.weidmueller.com

Accessories

WS 8/5



WS/ DEK

MultiMark terminal markers use an innovative composite material made from two components. The hard base contour of the marker snaps securely into the connector. The elastic surface finish makes the marker easy to mount. This specially punched material enables the strips to be stretched to accommodate the slight variations in spacing that tend to add up, especially with long terminal blocks. Another advantage: the excellent printability of the surface material guarantees durable and wear-resistant labelling. A print resolution of 300 dpi also produces a very legible script.

Your benefits with MultiMark

- Firm hold and durable printing
- Continuous strips save installation time
- Easy mounting thanks to an innovative composite material
- Large label field for optimal legibility
- High flexibility thanks to manufacturer independence

General ordering data

Type	WS 8/5 MM WS	Version	
Order No.	2007150000	WS, Terminal marker, 8 x 5 mm, Weidmueller, white	
GTIN (EAN)	4050118392029		
Qty.	800 ST		

Blank

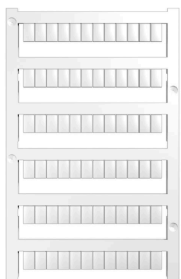

WS markers are the perfect match for the W-series connectors. Thanks to their system compatibility, the WS tags can also be used with the I-series and the Z-series. The large marking surfaces do not only permit long character strings but also multi-line text. WS markers are ideal for labels with long, customised character strings. Thanks to the proven MultiCard format, printing with PrintJet CONNECT oder/or Plotter is possible.

- Can be fitted in strips or individually
 - Markers in proven MultiCard format
- For custom printing: Please send us a file of our labeling software M-Print PRO or M-Print PRO Online (without installation) for your labeling specifications.

General ordering data

Type	WS 8/5 MC NE BL	Version	
Order No.	1773521693	WS, Terminal marker, 8 x 5 mm, Pitch in mm (P): 5.00 Weidmueller,	
GTIN (EAN)	4032248141715	Allen-Bradley, blue	
Qty.	720 ST		
Type	WS 8/5 MC NE GE	Version	
Order No.	1773521687	WS, Terminal marker, 8 x 5 mm, Pitch in mm (P): 5.00 Weidmueller,	
GTIN (EAN)	4032248141548	Allen-Bradley, yellow	
Qty.	720 ST		

S2C 2.5

Weidmüller Interface GmbH & Co. KG

Klingenbergstraße 26
D-32758 Detmold
Germany

www.weidmueller.com

Accessories

Type	WS 8/5 MC NE OR	Version
Order No.	1773521690	WS, Terminal marker, 8 x 5 mm, Pitch in mm (P): 5.00 Weidmueller,
GTIN (EAN)	4032248143092	Allen-Bradley, orange
Qty.	720 ST	
Type	WS 8/5 MC NE RT	Version
Order No.	1773521686	WS, Terminal marker, 8 x 5 mm, Pitch in mm (P): 5.00 Weidmueller,
GTIN (EAN)	4032248141531	Allen-Bradley, red
Qty.	720 ST	
Type	WS 8/5 MC NE WS	Version
Order No.	1640740000	WS, Terminal marker, 8 x 5 mm, Pitch in mm (P): 5.00 Weidmueller,
GTIN (EAN)	4008190279103	Allen-Bradley, white
Qty.	720 ST	

Custom printing



WS markers are the perfect match for the W-series connectors. Thanks to their system compatibility, the WS tags can also be used with the I-series and the Z-series. The large marking surfaces do not only permit long character strings but also multi-line text. WS markers are ideal for labels with long, customised character strings. Thanks to the proven MultiCard format, printing with PrintJet CONNECT oder/or Plotter is possible.

- Can be fitted in strips or individually
- Markers in proven MultiCard format

For custom printing: Please send us a file of our labeling software M-Print PRO or M-Print PRO Online (without installation) for your labeling specifications.

General ordering data

Type	WS 8/5 MC SDR	Version
Order No.	1640750000	WS, Terminal marker, 8 x 5 mm, Pitch in mm (P): 5.00 Weidmueller,
GTIN (EAN)	4008190456627	Allen-Bradley, To customer specification
Qty.	144 ST	

Blank

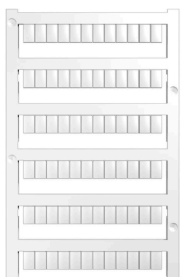

WS markers are the perfect match for the W-series connectors. Thanks to their system compatibility, the WS tags can also be used with the I-series and the Z-series. The large marking surfaces do not only permit long character strings but also multi-line text. WS markers are ideal for labels with long, customised character strings. Thanks to the proven MultiCard format, printing with PrintJet CONNECT oder/or Plotter is possible.

- Can be fitted in strips or individually
- Markers in proven MultiCard format

For custom printing: Please send us a file of our labeling software M-Print PRO or M-Print PRO Online (without installation) for your labeling specifications.

S2C 2.5

Weidmüller Interface GmbH & Co. KG
 Klingenbergstraße 26
 D-32758 Detmold
 Germany

www.weidmueller.com

Accessories

General ordering data

Type	WS 8/5 PLUS MC NE WS	Version	
Order No.	1951870000	WS, Terminal marker, 8 x 5 mm, Pitch in mm (P): 5.00 Weidmueller,	
GTIN (EAN)	4032248631605	Allen-Bradley, white	
Qty.	600 ST		

Custom printing



WS markers are the perfect match for the W-series connectors. Thanks to their system compatibility, the WS tags can also be used with the I-series and the Z-series. The large marking surfaces do not only permit long character strings but also multi-line text. WS markers are ideal for labels with long, customised character strings. Thanks to the proven MultiCard format, printing with PrintJet CONNECT oder/or Plotter is possible.

- Can be fitted in strips or individually
- Markers in proven MultiCard format

For custom printing: Please send us a file of our labeling software M-Print PRO or M-Print PRO Online (without installation) for your labeling specifications.

General ordering data

Type	WS 8/5 PLUS MC SDR	Version	
Order No.	1038790000	WS, Terminal marker, 8 x 5 mm, Pitch in mm (P): 5.00 Weidmueller,	
GTIN (EAN)	4032248768066	Allen-Bradley, To customer specification	
Qty.	120 ST		

Digital current clamp devices



Digital current clamp devices and attachments and adapters are used for measuring AC and DC currents. The significant advantage of these devices is that you can make a measurement without breaking the flow of current.

General ordering data

Type	ZUB MULTIMETER	Version	
Order No.	9205270000	Multimeter	
GTIN (EAN)	4032248723522		
Qty.	1 ST		

S2C 2.5

Weidmüller Interface GmbH & Co. KG

Klingenbergstraße 26

D-32758 Detmold

Germany

www.weidmueller.com

Accessories

A-Series

A

Series

Weidmüller's range of products includes end brackets that guarantee a permanent, reliable mounting on the terminal rail and prevent sliding. Versions with and without screws are available. The end brackets include marking options, also for group markers, and also a test plug holder.

General ordering data

Type	AEB 35 SC/1 BK	Version	
Order No.	2475310000	Version	A-series, End bracket
GTIN (EAN)	4050118487114		
Qty.	50 ST		

Marker holder

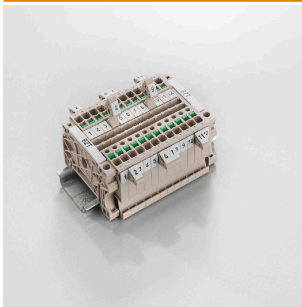

The marker holder offer the possibility of additional mounting of standard markers with a pitch of 5 or 5.1 mm. The angled holders can be optionally snapped together and could be mounted in all standard marking channels of the Klippon® Connect modular terminal blocks. Fitting marker types could be found under the respective accessories of the designation marking holder.

General ordering data

Type	BZT 1 WS 10/5	Version	
Order No.	1805490000	Version	Accessories, Marker holder
GTIN (EAN)	4032248270231		
Qty.	100 ST		
Type	BZT 1 ZA WS 10/5	Version	
Order No.	1805520000	Version	Accessories, Marker holder
GTIN (EAN)	4032248270248		
Qty.	100 ST		

A-Series

A

Series

A partition plate is used for the optical separation of circuits or used for electrical isolation from neighbouring cross-connectors. In contrast to the end plate, the contour can be larger than the adjacent terminal blocks. However, it should not be smaller, as otherwise the required clearance and creepage distances within the application can no longer be maintained.

S2C 2.5

Weidmüller Interface GmbH & Co. KG
 Klingenbergstraße 26
 D-32758 Detmold
 Germany

www.weidmueller.com

Accessories

General ordering data

Type	APP 1	Version
Order No.	2488970000	A-series, Partition plate
GTIN (EAN)	4050118499216	
Qty.	50 ST	
Type	AEB 35 SCL/1 V0	Version
Order No.	2661280000	A-series, End bracket
GTIN (EAN)	4050118702163	
Qty.	20 ST	
Type	AEB 35 SCL/1 V0 BK	Version
Order No.	2661300000	A-series, End bracket
GTIN (EAN)	4050118702187	
Qty.	20 ST	
Type	AEB 35 SCL/1 V0 GY	Version
Order No.	2661290000	A-series, End bracket
GTIN (EAN)	4050118702170	
Qty.	20 ST	

Z-Series

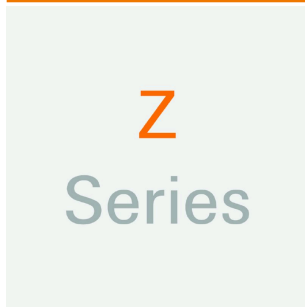

Weidmüller's range of products includes end brackets that guarantee a permanent, reliable mounting on the terminal rail and prevent sliding. Versions with and without screws are available. The end brackets include marking options, also for group markers, and also a test plug holder.

General ordering data

Type	ZST 1	Version
Order No.	1269070000	Accessories, Accessories holder
GTIN (EAN)	4050118094091	
Qty.	25 ST	
Type	ZST	Version
Order No.	1678680000	Z-series, Accessories holder
GTIN (EAN)	4008190466770	
Qty.	10 ST	

2.5 mm²

S2C 2.5

Weidmüller Interface GmbH & Co. KG
 Klingenbergstraße 26
 D-32758 Detmold
 Germany

www.weidmueller.com

Accessories

General ordering data

Type	SEP 2C 2.5	Version	
Order No.	2751080000	End plate for terminals, dark beige, Height: 56.9 mm, Width: 2.1 mm,	
GTIN (EAN)	4064675267607	V-0, Wemid, Snap-on: Yes	
Qty.	20 ST		

Slotted screwdriver

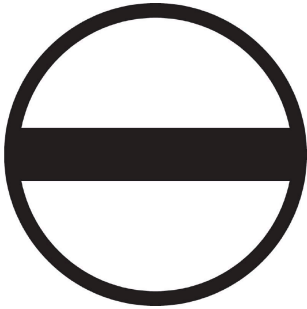

VDE insulated screwdriver sets, for working on live parts up to 1000 V AC and 1500 V DC, DIN EN 60900. IEC 900. Each piece is "GS" safety tested. Blade made from fully hardened, high-alloy chromium-vanadium-molybdenum steel, gun-metal finish.

General ordering data

Type	SDIS SLIM 0.6X3.5X100	Version	
Order No.	2749610000	Mounting tool, Blade width (B): 3.5 mm, Blade length: 100 mm, Blade	
GTIN (EAN)	4050118896350	thickness (A): 0.6 mm	
Qty.	1 ST		