

# UKH 70 - High-current terminal block



3213140

<https://www.phoenixcontact.com/gb/products/3213140>

Please be informed that the data shown in this PDF document is generated from our online catalog. Please find the complete data in the user documentation. Our general terms of use for downloads are valid.



High-current terminal block, nom. voltage: 1000 V, nominal current: 192 A, number of connections: 2, number of positions: 1, connection method: Screw connection, Rated cross section: 70 mm<sup>2</sup>, cross section: 16 mm<sup>2</sup> - 95 mm<sup>2</sup>, mounting type: NS 35/7,5, NS 35/15, NS 35/15-2,3, NS 32, color: gray

## Your advantages

- Reliable cable connection is ensured by three-point centering of the conductor in the prismatic sleeve base
- Tested for railway applications
- Low contact resistance of the contact surface due to ribbing
- Screw locking by means of spring-loaded elements in the clamping part

## Commercial data

Item number	3213140
Packing unit	10 pc
Minimum order quantity	10 pc
Sales key	BE1311
Product key	BE1311
GTIN	4046356549202
Weight per piece (including packing)	153.39 g
Weight per piece (excluding packing)	147.225 g
Customs tariff number	85369010
Country of origin	CN

# UKH 70 - High-current terminal block



3213140

<https://www.phoenixcontact.com/gb/products/3213140>

## Technical data

### Notes

#### General

Note	For a reliable contact of multi stranded conductors it is recommended to untwist multi stranded conductors.
------	---

### Product properties

Product type	High current terminal block
Area of application	Railway industry
	Machine building
	Plant engineering
Number of positions	1
Number of connections	2
Number of rows	1
Potentials	1

#### Insulation characteristics

Overvoltage category	III
Degree of pollution	3

### Electrical properties

Rated surge voltage	8 kV
Maximum power dissipation for nominal condition	6.27 W

### Connection data

Number of connections per level	2
Nominal cross section	70 mm <sup>2</sup>

#### Level 1 above 1 below 1

Connection method	Screw connection
Screw thread	M8
Tightening torque	8 ... 10 Nm
Stripping length	24 mm
Internal cylindrical gage	A11
Connection in acc. with standard	IEC 60947-7-1
Conductor cross-section rigid	16 mm <sup>2</sup> ... 95 mm <sup>2</sup>
Cross section AWG	4 ... 3/0 (converted acc. to IEC)
Conductor cross-section flexible	25 mm <sup>2</sup> ... 70 mm <sup>2</sup>
Conductor cross-section, flexible [AWG]	2 ... 2/0 (converted acc. to IEC)
Conductor cross-section flexible (ferrule without plastic sleeve)	16 mm <sup>2</sup> ... 70 mm <sup>2</sup>
Flexible conductor cross-section (ferrule with plastic sleeve)	16 mm <sup>2</sup> ... 70 mm <sup>2</sup>
2 conductors with same cross section, solid	16 mm <sup>2</sup> ... 25 mm <sup>2</sup>
2 conductors with same cross section, flexible	16 mm <sup>2</sup> ... 25 mm <sup>2</sup>

# UKH 70 - High-current terminal block



3213140

<https://www.phoenixcontact.com/gb/products/3213140>

2 conductors with same cross section, flexible, with ferrule without plastic sleeve	16 mm <sup>2</sup> ... 25 mm <sup>2</sup>
Nominal current	192 A
Maximum load current	192 A (with 70 mm <sup>2</sup> conductor cross-section)
Nominal voltage	1000 V
Note	Note: Product releases, connection cross sections and notes on connecting aluminum cables can be found in the download area.
Nominal cross section	70 mm <sup>2</sup>

## Ex data

### Rated data (ATEX/IECEx)

Identification	Ⓔ II 2 GD Ex eb IIC Gb
Operating temperature range	-60 °C ... 110 °C
Ex-certified accessories	1201934 VDE-ISS 6
	1201659 E/AL-NS 32
	1201662 E/AL-NS 35
List of bridges	/ FBI 2-20 N EX / 3213210
	/ FBI 3-20 N EX / 3213211
Bridge data	180 A (70 mm <sup>2</sup> )
Ex temperature increase	40 K (180 A / 70 mm <sup>2</sup> )
Rated insulation voltage	800 V (NS 35)
	630 V (NS 32)
output	(Permanent)

### Ex level General

Rated voltage	880 V (NS 35)
	690 V (NS 32)
Rated current	180 A
Maximum load current	180 A
Contact resistance	0.08 mΩ

### Ex connection data General

Torque range	8 Nm ... 10 Nm
Nominal cross section	70 mm <sup>2</sup>
Rated cross section AWG	2/0
Connection capacity rigid	16 mm <sup>2</sup> ... 95 mm <sup>2</sup>
Connection capacity AWG	4 ... 3/0
Connection capacity flexible	25 mm <sup>2</sup> ... 70 mm <sup>2</sup>
Connection capacity AWG	3 ... 2/0
2 conductors with same cross section, solid	16 mm <sup>2</sup> ... 25 mm <sup>2</sup>
2 conductors with the same cross-section AWG rigid	4 ... 3
2 conductors with same cross section, stranded	16 mm <sup>2</sup> ... 25 mm <sup>2</sup>
2 conductors with the same cross-section AWG flexible	4 ... 3

## Dimensions

# UKH 70 - High-current terminal block



3213140

<https://www.phoenixcontact.com/gb/products/3213140>

Width	20.3 mm
Height	70.5 mm
Depth	78.3 mm
Depth on NS 32	85 mm
Depth on NS 35/7,5	80 mm
Depth on NS 35/15	87.5 mm

## Material specifications

Color	gray (RAL 7042)
Flammability rating according to UL 94	V0
Insulating material group	I
Insulating material	PA
Static insulating material application in cold	-60 °C
Relative insulation material temperature index (Elec., UL 746 B)	130 °C
Fire protection for rail vehicles (DIN EN 45545-2) R22	HL 1 - HL 3
Fire protection for rail vehicles (DIN EN 45545-2) R23	HL 1 - HL 3
Fire protection for rail vehicles (DIN EN 45545-2) R24	HL 1 - HL 3
Fire protection for rail vehicles (DIN EN 45545-2) R26	HL 1 - HL 3
Surface flammability NFPA 130 (ASTM E 162)	passed
Specific optical density of smoke NFPA 130 (ASTM E 662)	passed
Smoke gas toxicity NFPA 130 (SMP 800C)	passed

## Electrical tests

### Surge voltage test

Test voltage setpoint	9.8 kV
Result	Test passed

### Temperature-rise test

Requirement temperature-rise test	Increase in temperature $\leq 45$ K
Result	Test passed
Short-time withstand current 70 mm <sup>2</sup>	8.4 kA
Result	Test passed

### Power-frequency withstand voltage

Test voltage setpoint	2.2 kV
Result	Test passed

## Mechanical properties

### Mechanical data

Open side panel	No
-----------------	----

## Mechanical tests

### Mechanical strength

Result	Test passed
--------	-------------

## Attachment on the carrier

DIN rail/fixing support	NS 32/NS 35
Test force setpoint	10 N
Result	Test passed

## Test for conductor damage and slackening

Rotation speed	10 (+/- 2) rpm
Revolutions	135
Conductor cross-section/weight	16 mm <sup>2</sup> / 2.9 kg
	70 mm <sup>2</sup> /10.4 kg
	95 mm <sup>2</sup> /14 kg
Result	Test passed

## Environmental and real-life conditions

### Needle-flame test

Time of exposure	30 s
Result	Test passed

### Oscillation/broadband noise

Specification	DIN EN 50155 (VDE 0115-200):2022-06
Spectrum	Long life test category 2, bogie-mounted
Frequency	$f_1 = 5 \text{ Hz}$ to $f_2 = 250 \text{ Hz}$
ASD level	6.12 (m/s <sup>2</sup> ) <sup>2</sup> /Hz
Acceleration	3.12g
Test duration per axis	5 h
Test directions	X-, Y- and Z-axis
Result	Test passed

### Shocks

Specification	DIN EN 50155 (VDE 0115-200):2022-06
Pulse shape	Half-sine
Acceleration	5g
Shock duration	30 ms
Number of shocks per direction	3
Test directions	X-, Y- and Z-axis (pos. and neg.)
Result	Test passed

### Ambient conditions

Ambient temperature (operation)	-60 °C ... 110 °C (Operating temperature range incl. self-heating; for max. short-term operating temperature, see RTI Elec.)
Ambient temperature (storage/transport)	-25 °C ... 60 °C (for a short time, not exceeding 24 h, -60 °C to +70 °C)
Ambient temperature (assembly)	-5 °C ... 70 °C
Ambient temperature (actuation)	-5 °C ... 70 °C
Permissible humidity (operation)	20 % ... 90 %

# UKH 70 - High-current terminal block



3213140

<https://www.phoenixcontact.com/gb/products/3213140>

Permissible humidity (storage/transport)	30 % ... 70 %
--	---------------

## Standards and regulations

Connection in acc. with standard	IEC 60947-7-1
----------------------------------	---------------

## Mounting

Mounting type	NS 35/7,5
	NS 35/15
	NS 35/15-2,3
	NS 32

# UKH 70 - High-current terminal block

3213140

<https://www.phoenixcontact.com/gb/products/3213140>

## Drawings

Schematic diagram

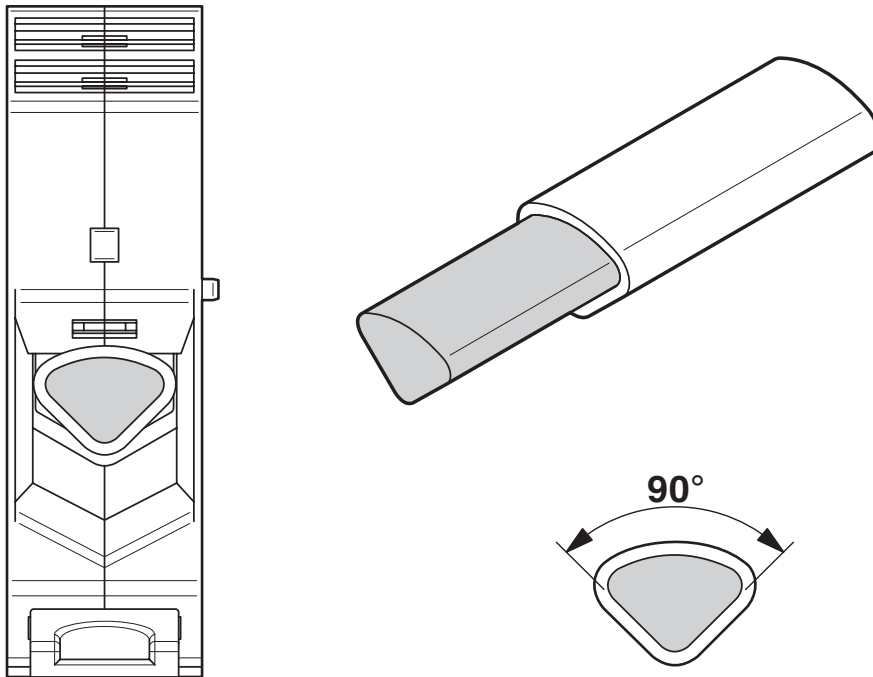

Connecting aluminum cables. Further notes can be found in the download area

Circuit diagram



# UKH 70 - High-current terminal block





3213140

<https://www.phoenixcontact.com/gb/products/3213140>

## Approvals

To download certificates, visit the product detail page: <https://www.phoenixcontact.com/gb/products/3213140>

 <b>CSA</b> Approval ID: 13631				
	Nominal voltage $U_N$	Nominal current $I_N$	Cross section AWG	Cross section $mm^2$
B	1000 V	192 A	6 - 3/0	-
C	600 V	192 A	6 - 3/0	-

 <b>IECEE CB Scheme</b> Approval ID: DE1-62936_M1				
	Nominal voltage $U_N$	Nominal current $I_N$	Cross section AWG	Cross section $mm^2$
keine	1000 V	192 A	-	- 70

 <b>cULus Recognized</b> Approval ID: E60425				
	Nominal voltage $U_N$	Nominal current $I_N$	Cross section AWG	Cross section $mm^2$
C	1000 V	192 A	6 - 3/0	-
E	1000 V	192 A	6 - 3/0	-

 <b>LR</b> Approval ID: LR2420186TA				
---	--	--	--	--

 <b>VDE Zeichengenehmigung</b> Approval ID: 40036368				
	Nominal voltage $U_N$	Nominal current $I_N$	Cross section AWG	Cross section $mm^2$
keine	1000 V	192 A	-	- 70

<b>DNV</b> Approval ID: TAE00001CT				
---------------------------------------	--	--	--	--

 <b>EAC Ex</b> Approval ID: KZ 7500525010101950				
---	--	--	--	--

# UKH 70 - High-current terminal block



3213140

<https://www.phoenixcontact.com/gb/products/3213140>

 <b>IECEX</b> Approval ID: IECEx SEV12.0008U				
	Nominal voltage $U_N$	Nominal current $I_N$	Cross section AWG	Cross section $\text{mm}^2$
keine				
Mounting on NS 32	690 V	180 A	-	25 - 70
Mounting on NS 35	880 V	180 A	-	25 - 70

 <b>ATEX</b> Approval ID: SEV12ATEX0168U				
	Nominal voltage $U_N$	Nominal current $I_N$	Cross section AWG	Cross section $\text{mm}^2$
keine				
Mounting on NS 32	690 V	180 A	-	25 - 70
Mounting on NS 35	880 V	180 A	-	25 - 70

 <b>CCC</b> Approval ID: 2020322313000623				
---	--	--	--	--

<b>UL Comp Hazloc CA US</b> Approval ID: UL UL CA L 192998				
	Nominal voltage $U_N$	Nominal current $I_N$	Cross section AWG	Cross section $\text{mm}^2$
keine				
	880 V	192 A	6 - 3/0	-

# UKH 70 - High-current terminal block



3213140

<https://www.phoenixcontact.com/gb/products/3213140>

## Classifications

### ECLASS

ECLASS-13.0	27250101
ECLASS-15.0	27250101

### ETIM

ETIM 9.0	EC000897
----------	----------

### UNSPSC

UNSPSC 21.0	39121400
-------------	----------

# UKH 70 - High-current terminal block



3213140

<https://www.phoenixcontact.com/gb/products/3213140>

## Environmental product compliance

### EU RoHS

Fulfills EU RoHS substance requirements	Yes, No exemptions
---	--------------------

### China RoHS

Environment friendly use period (EFUP)	EFUP-E
	No hazardous substances above the limits

### EU REACH SVHC

REACH candidate substance (CAS No.)	No substance above 0.1 wt%
-------------------------------------	----------------------------

Phoenix Contact 2025 © - all rights reserved  
<https://www.phoenixcontact.com>

PHOENIX CONTACT Ltd  
Halesfield 13, Telford  
Shropshire, TF7 4PG  
01952 681700  
[info@phoenixcontact.co.uk](mailto:info@phoenixcontact.co.uk)