

Product datasheet

Specifications



Light block, Harmony XB4, Harmony XB5, for head 22mm, universal LED, 24V AC DC, compact push in terminals

Local distributor code:
398217518

ZBVB15

EAN Code: 3389119037495

Main

Range of product	Harmony XB4 Harmony XB5
Product or component type	Light block
Device short name	ZBV
Sale per indivisible quantity	5
Connections - terminals	Push-in, $\leq 2 \times 1.5 \text{ mm}^2$ with wire end ferrule conforming to IEC 60947-1 Push-in, $\geq 1 \times 0.34 \text{ mm}^2$ without wire end ferrule conforming to IEC 60947-1
Signalling type	Steady
Light source	Universal LED
Bulb base	Integral LED
Light block supply	Direct
Light source colour	White
[Us] rated supply voltage	24 V AC/DC at 50/60 Hz

Complementary

CAD overall width	35.6 mm
CAD overall height	14.8 mm
CAD overall depth	9.8 mm
Net weight	0.005 kg
Supply voltage limits	20.4...26.4 V DC 20.4...26.4 V AC
Current consumption	15 mA
Service life	100000 h at rated voltage and 25 °C
Surge withstand	1 kV conforming to IEC 61000-4-5
Mounting of block	Front mounting
Device presentation	Basic element

Environment

Protective treatment	TH
Ambient air temperature for storage	-40...70 °C
Ambient air temperature for operation	-40...70 °C
IP degree of protection	IP20 conforming to IEC 60529

Standards	IEC 60947-1 IEC 60947-5-1 IEC 60947-5-4 IEC 60947-5-5 UL 60947-1 UL 60947-5-1 UL 60947-5-5 UL 1059 UL 486E CSA C22.2 No 60947-1 CSA C22.2 No 60947-5-1 CSA C22.2 No 158 CSA C22.2 No 65 IACS E10
Product certifications	EAC IECEE CB Scheme CCC UL CSA
Resistance to fast transients	2 kV conforming to IEC 61000-4-4
Resistance to electromagnetic fields	10 V/m conforming to IEC 61000-4-3
Resistance to electrostatic discharge	4 kV on contact (on metal parts) conforming to IEC 61000-4-2 8 kV in free air (in insulating parts) conforming to IEC 61000-4-2
Electromagnetic emission	Class B conforming to IEC 55011
[Us] rated supply voltage	24 V

Packing Units

Unit Type of Package 1	PCE
Number of Units in Package 1	1
Package 1 Height	4.3 cm
Package 1 Width	5.2 cm
Package 1 Length	5.4 cm
Package 1 Weight	5 g
Unit Type of Package 2	BB1
Number of Units in Package 2	5
Package 2 Height	4.3 cm
Package 2 Width	5.2 cm
Package 2 Length	5.4 cm
Package 2 Weight	30 g
Unit Type of Package 3	S03
Number of Units in Package 3	800
Package 3 Height	30 cm
Package 3 Width	30 cm
Package 3 Length	40 cm
Package 3 Weight	5.241 kg

Logistical informations

Country of origin	FR
--------------------------	----

Contractual warranty



Environmental Data

Schneider Electric aims to achieve Net Zero status by 2050 through supply chain partnerships, lower impact materials, and circularity via our ongoing “Use Better, Use Longer, Use Again” campaign to extend product lifetimes and recyclability.

[Environmental Data explained >](#)

[How we assess product sustainability >](#)

Environmental footprint

Total lifecycle Carbon footprint 5

Environmental Disclosure [Product Environmental Profile](#)

Use Better

Materials and Substances

Packaging made with recycled cardboard No

Packaging without single use plastic No

[EU RoHS Directive](#) Pro-active compliance (Product out of EU RoHS legal scope)

SCIP Number E148b25a-d37b-4237-bc1f-74823046728d

REACH Regulation [REACH Declaration](#)

Use Again

Repack and remanufacture

End of life manual availability [End of Life Information](#)

Take-back No

WEEE Label  The product must be disposed on European Union markets following specific waste collection and never end up in rubbish bins

Dimensions Drawings

Dimensions

with ZB5AZ009 Fixing Collar

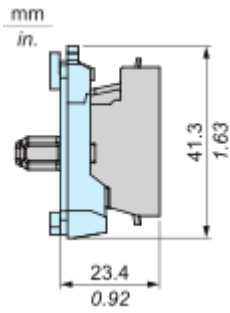

with ZB4BZ009 Fixing Collar

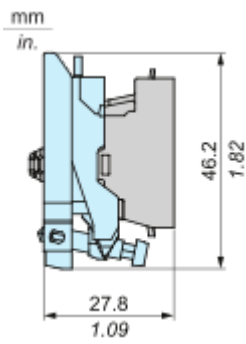

Mounting and Clearance

Mounting

Mounting and Unmounting



Panel cut-out Dimension

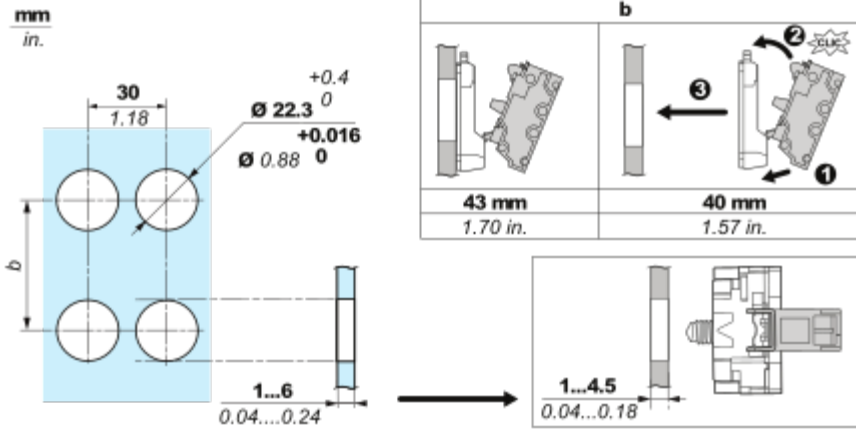

Connections and Schema

Wiring

Wiring and Unwiring



mm	8
in.	0.32
mm ²	0.34...1.5
AWG	22...16

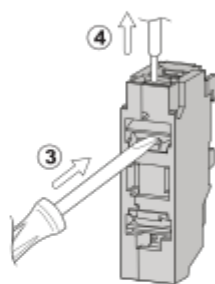
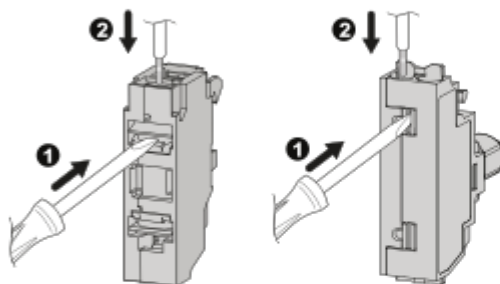
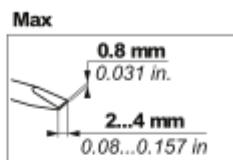

mm	8	8	8
in.	0.32	0.32	0.32
mm ²	0.34...1.5	0.34...1	0.34...1.5
AWG	22...16	22...18	22...16

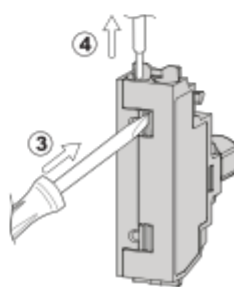
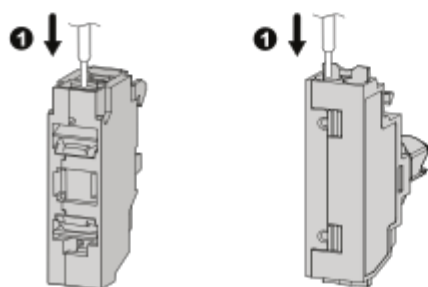

Technical Illustration

Dimensions

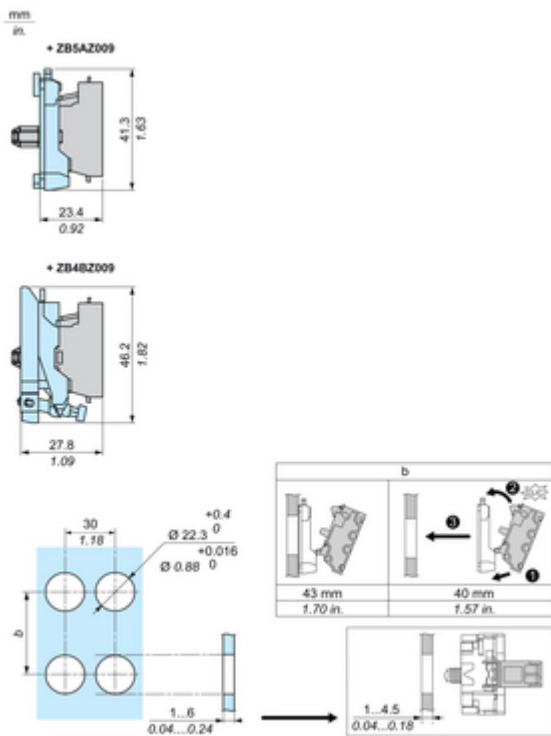

Technical Illustration

Wiring diagram

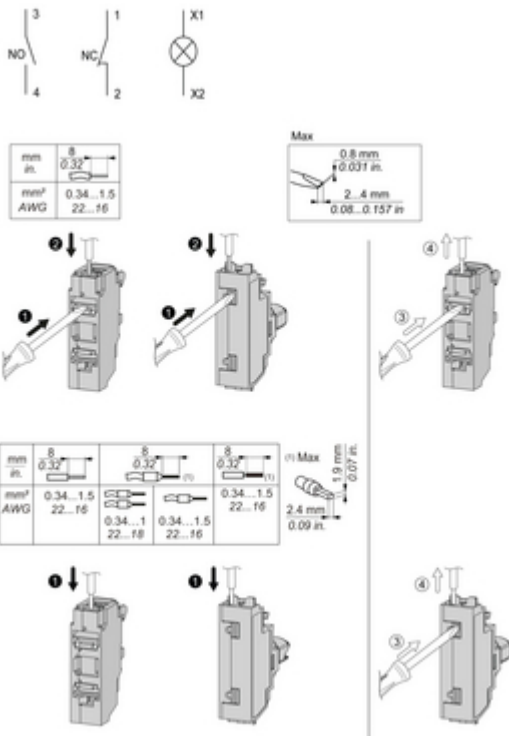

Offer Marketing Illustration

Product benefits / Features

Technical Benefits

Harmony XB4

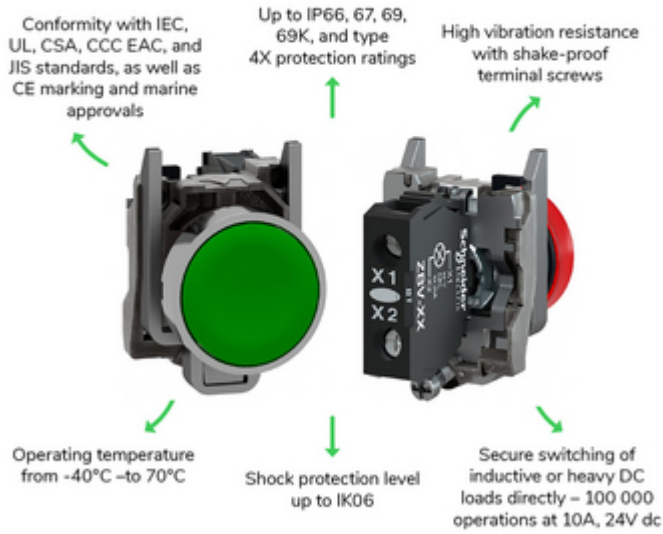

Offer Marketing Illustration

Product benefits / Features

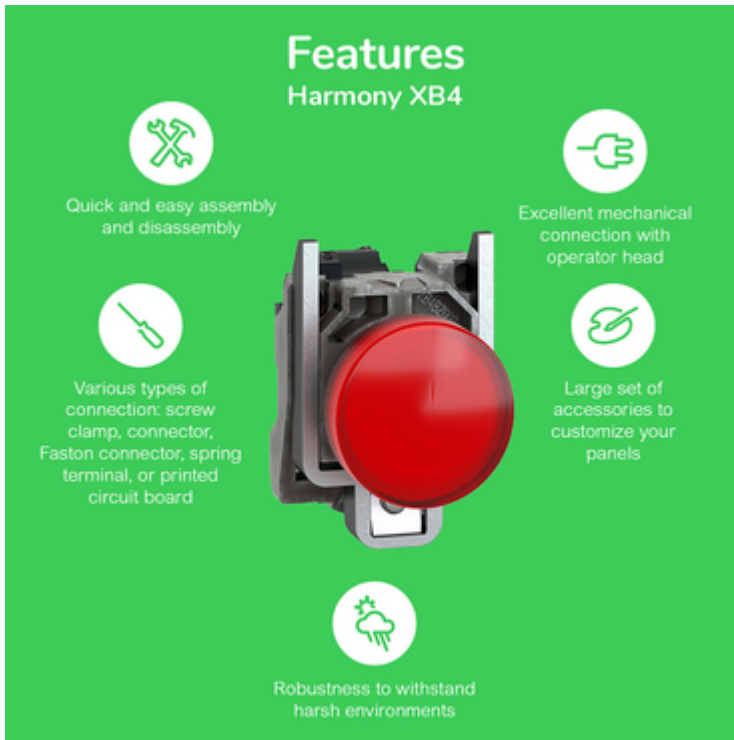

The infographic features a central image of a red Schneider XB4 circuit breaker. Surrounding this central image are five circular icons, each with a corresponding text description of a product feature. The background is a solid green color.

Features Harmony XB4

- Quick and easy assembly and disassembly** (Icon: crossed wrench and screwdriver)
- Excellent mechanical connection with operator head** (Icon: hand holding a plug)
- Large set of accessories to customize your panels** (Icon: plug with a slash)
- Robustness to withstand harsh environments** (Icon: lightning bolt and rain cloud)
- Various types of connection: screw clamp, connector, Faston connector, spring terminal, or printed circuit board** (Icon: screwdriver)

Offer Marketing Illustration

Product benefits / Features

Features
Harmony XB4/XB5 Compact Push-in blocks



37% thinner than a standard block

Installation costs saved through reduced wiring time and effort

Fully compatible with current Harmony offer

Available as single block, sub-assemblies and complete units (both plastic and metal ranges)

Simplified inventory management

Offer Marketing Illustration

Product benefits / Features

Technical Benefits

Harmony XB4/XB5 Compact Push-in blocks

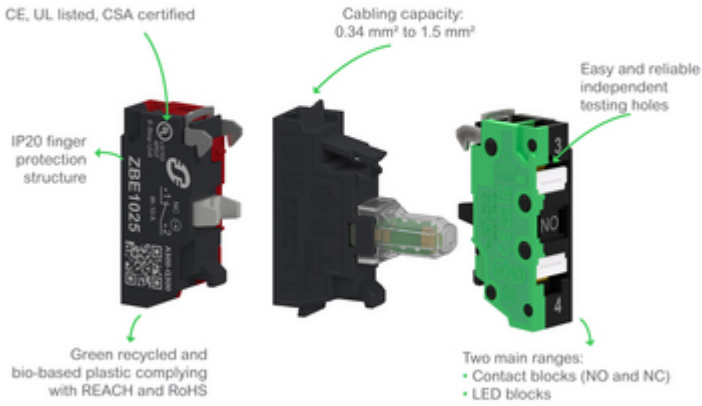

Image of product / Alternate images

Alternative

