

# Product datasheet

Specifications



## Illuminated push button, Harmony XB4, metal, red flush mounted, 30mm, universal LED, plain lens, 1NO + 1NC, 230V AC

Local distributor code:

407813311

XB4FW34M5

**Important message: A change in appearance may be noted on the product but does not affect its use in terms of function and safety. This makes it compatible with our Universal LED blocks**  
**EAN Code: 3606489580711**

### Main

Range of product	Harmony XB4
Product or component type	Illuminated push-button
Device short name	XB4F
Bezel material	Chromium plated metal
Fixing collar material	Zamak
Mounting diameter	30.5 mm
Sale per indivisible quantity	1
Head type	Built-in-flush
Shape of signaling unit head	Round
Type of operator	spring return
Operator profile	Red flush
Operator additional information	With plain lens
Contacts type and composition	1 NO + 1 NC
Contact operation	Slow-break
Connections - terminals	Screw clamp terminals, $\leq 2 \times 1.5 \text{ mm}^2$ with cable end conforming to IEC 60947-1 Screw clamp terminals, $1 \times 0.22 \dots 2 \times 2.5 \text{ mm}^2$ without cable end conforming to IEC 60947-1
Light source	Universal LED
Bulb base	Integral LED
[Us] rated supply voltage	230...240 V AC at 50/60 Hz

### Complementary

Height	47 mm
Width	36.6 mm
Depth	55 mm
Terminals description ISO n°1	(13-14)NO (21-22)NC
Net weight	0.132 kg
Resistance to high pressure washer	7000000 Pa at 55 °C, distance : 0.1 m
Device mounting	Built-in

<b>Fixing mode</b>	By screws recommended torque: 0.8 N.m
<b>Contacts usage</b>	Standard contacts
<b>Positive opening</b>	With conforming to IEC 60947-5-1 appendix K
<b>Operating travel</b>	1.5 mm (NC changing electrical state) 2.6 mm (NO changing electrical state) 4.3 mm (total travel)
<b>Operating force</b>	3.5 N NC changing electrical state 3.8 N
<b>Mechanical durability</b>	10000000 cycles
<b>Tightening torque</b>	0.8...1.2 N.m conforming to IEC 60947-1
<b>Shape of screw head</b>	Cross compatible with Philips no 1 screwdriver Cross compatible with pozidriv No 1 screwdriver Slotted compatible with flat Ø 4 mm screwdriver Slotted compatible with flat Ø 5.5 mm screwdriver
<b>Contacts material</b>	Silver alloy (Ag/Ni)
<b>Short-circuit protection</b>	10 A cartridge fuse type gG conforming to IEC 60947-5-1
<b>[Ith] conventional free air thermal current</b>	10 A conforming to IEC 60947-5-1
<b>[Ui] rated insulation voltage</b>	600 V (pollution degree 3) conforming to IEC 60947-1
<b>[Uimp] rated impulse withstand voltage</b>	6 kV conforming to IEC 60947-1
<b>[Ie] rated operational current</b>	3 A at 240 V, AC-15, A600 conforming to IEC 60947-5-1 6 A at 120 V, AC-15, A600 conforming to IEC 60947-5-1 0.1 A at 600 V, DC-13, Q600 conforming to IEC 60947-5-1 0.27 A at 250 V, DC-13, Q600 conforming to IEC 60947-5-1 0.55 A at 125 V, DC-13, Q600 conforming to IEC 60947-5-1 1.2 A at 600 V, AC-15, A600 conforming to IEC 60947-5-1
<b>Electrical durability</b>	1000000 cycles, AC-15, 2 A at 230 V, operating rate <3600 cyc/h, load factor: 0.5 conforming to IEC 60947-5-1 appendix C 1000000 cycles, AC-15, 3 A at 120 V, operating rate <3600 cyc/h, load factor: 0.5 conforming to IEC 60947-5-1 appendix C 1000000 cycles, AC-15, 4 A at 24 V, operating rate <3600 cyc/h, load factor: 0.5 conforming to IEC 60947-5-1 appendix C 1000000 cycles, DC-13, 0.2 A at 110 V, operating rate <3600 cyc/h, load factor: 0.5 conforming to IEC 60947-5-1 appendix C 1000000 cycles, DC-13, 0.5 A at 24 V, operating rate <3600 cyc/h, load factor: 0.5 conforming to IEC 60947-5-1 appendix C
<b>Electrical reliability</b>	$\Lambda < 10\text{exp}(-6)$ at 5 V and 1 mA in clean environment conforming to IEC 60947-5-4 $\Lambda < 10\text{exp}(-8)$ at 17 V and 5 mA in clean environment conforming to IEC 60947-5-4
<b>Signalling type</b>	Steady
<b>Current consumption</b>	14 mA
<b>Service life</b>	100000 h at rated voltage and 25 °C
<b>Surge withstand</b>	1 kV conforming to IEC 61000-4-5
<b>Supply voltage limits</b>	195...264 V AC
<b>Device presentation</b>	Complete product

## Environment

<b>Protective treatment</b>	TH
<b>Ambient air temperature for storage</b>	-40...70 °C
<b>Ambient air temperature for operation</b>	-40...70 °C
<b>Electrical shock protection class</b>	Class I conforming to IEC 60536

<b>IP degree of protection</b>	IP66 conforming to IEC 60529 IP67 conforming to IEC 60529 IP69 conforming to IEC 60529 IP69K conforming to ISO 20653 Type 13 conforming to UL 50 E Type 12 conforming to UL 50 E Type 4 conforming to UL 50 E Type 4X conforming to UL 50 E
<b>IK degree of protection</b>	IK06 conforming to IEC 50102
<b>Standards</b>	CSA C22.2 No 14 IEC 60947-5-1 IEC 60947-5-4 UL 508 IEC 60947-1 JIS C8201-5-1 CE JIS C8201-1
<b>Product certifications</b>	UL listed CSA CCC EAC
<b>Vibration resistance</b>	5 gn (f= 10...500 Hz) conforming to IEC 60068-2-6 2 mm peak to peak (f= 2...10 Hz) conforming to IEC 60068-2-6
<b>Shock resistance</b>	30 gn (duration = 18 ms) for half sine wave acceleration conforming to IEC 60068-2-27 50 gn (duration = 11 ms) for half sine wave acceleration conforming to IEC 60068-2-27 25 gn (duration = 6 ms) for 1000 shocks on each axis conforming to IEC 60068-2-27
<b>Resistance to fast transients</b>	2 kV conforming to IEC 61000-4-4
<b>Resistance to electromagnetic fields</b>	10 V/m conforming to IEC 61000-4-3
<b>Resistance to electrostatic discharge</b>	6 kV on contact (on metal parts) conforming to IEC 61000-4-2 8 kV in free air (in insulating parts) conforming to IEC 61000-4-2
<b>Electromagnetic emission</b>	Class B conforming to IEC 55011

## Packing Units

<b>Unit Type of Package 1</b>	PCE
<b>Number of Units in Package 1</b>	1
<b>Package 1 Height</b>	8.600 cm
<b>Package 1 Width</b>	5.200 cm
<b>Package 1 Length</b>	4.300 cm
<b>Package 1 Weight</b>	126.000 g
<b>Unit Type of Package 2</b>	S02
<b>Number of Units in Package 2</b>	40
<b>Package 2 Height</b>	15.000 cm
<b>Package 2 Width</b>	30.000 cm
<b>Package 2 Length</b>	40.000 cm
<b>Package 2 Weight</b>	5.440 kg

## Logistical informations

<b>Country of origin</b>	FR
--------------------------	----

## Contractual warranty

<b>Warranty (in months)</b>	18
-----------------------------	----



## Environmental Data

Schneider Electric aims to achieve Net Zero status by 2050 through supply chain partnerships, lower impact materials, and circularity via our ongoing “Use Better, Use Longer, Use Again” campaign to extend product lifetimes and recyclability.

[Environmental Data explained >](#)

[How we assess product sustainability >](#)

### Environmental footprint

Total lifecycle Carbon footprint 4

Environmental Disclosure [Product Environmental Profile](#)

## Use Better

### Materials and Substances

Packaging made with recycled cardboard Yes

Packaging without single use plastic Yes

[EU RoHS Directive](#) Pro-active compliance (Product out of EU RoHS legal scope)

SCIP Number 425812e5-011f-4fb4-ad1b-fc9cf9865300

REACH Regulation [REACH Declaration](#)

## Use Longer

### Lifetime extension

Product repair index [A](#)

## Use Again

### Repack and remanufacture

End of life manual availability [End of Life Information](#)

Take-back No

WEEE Label  The product must be disposed on European Union markets following specific waste collection and never end up in rubbish bins

Dimensions Drawings

Dimensions

---

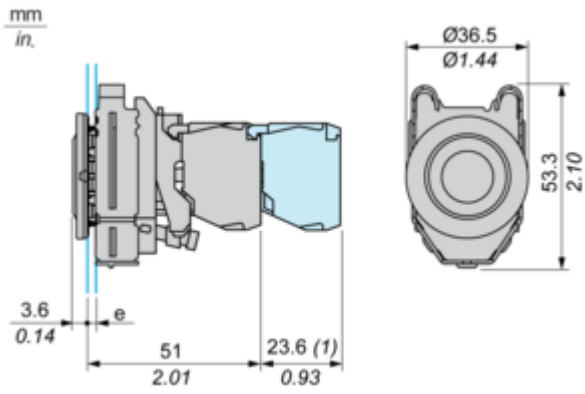

e : clamping thickness: 1 to 6 mm / 0.04 to 0.24 in.  
(1) : Additional row of contacts

Mounting and Clearance

**Panel Cut-out for Pushbuttons, Switches and Pilot Lights (Finished Holes, Ready for Installation)**

---

**Connection by Screw Clamp Terminals or Plug-in Connectors**

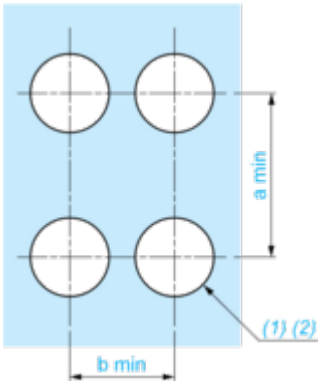

(1) : Diameter on finished panel or support

(2) :  $\varnothing 30.75$  mm recommended ( $\varnothing 30.5_0^{+0.5}$ ) /  $\varnothing 1.21$  in. recommended ( $\varnothing 1.20$  in.  $_0^{+0.0196}$ )

Connections	a in mm	a in in.	b in mm	b in in.
By connectors	50	1.97	40	1.57
By connectors and with legend holder ZBZF32	50	1.97	40	1.57
By connectors and with legend holder ZBZF33	60	2.36	40	1.57

Technical Illustration

Dimensions

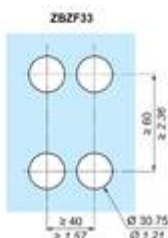
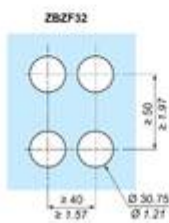
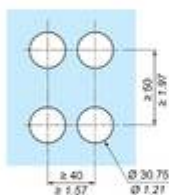
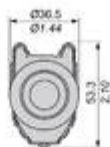
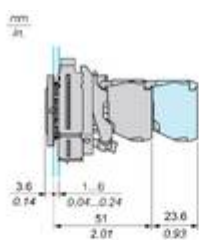

Offer Marketing Illustration

Product benefits / Features

---

## Technical Benefits

### Harmony XB4

Conformity with IEC, UL, CSA, CCC EAC, and JIS standards, as well as CE marking and marine approvals

Up to IP66, 67, 69, 69K, and type 4X protection ratings

High vibration resistance with shake-proof terminal screws



Operating temperature from -40°C to 70°C

Shock protection level up to IK06

Secure switching of inductive or heavy DC loads directly – 100 000 operations at 10A, 24V dc

Offer Marketing Illustration

Product benefits / Features

---

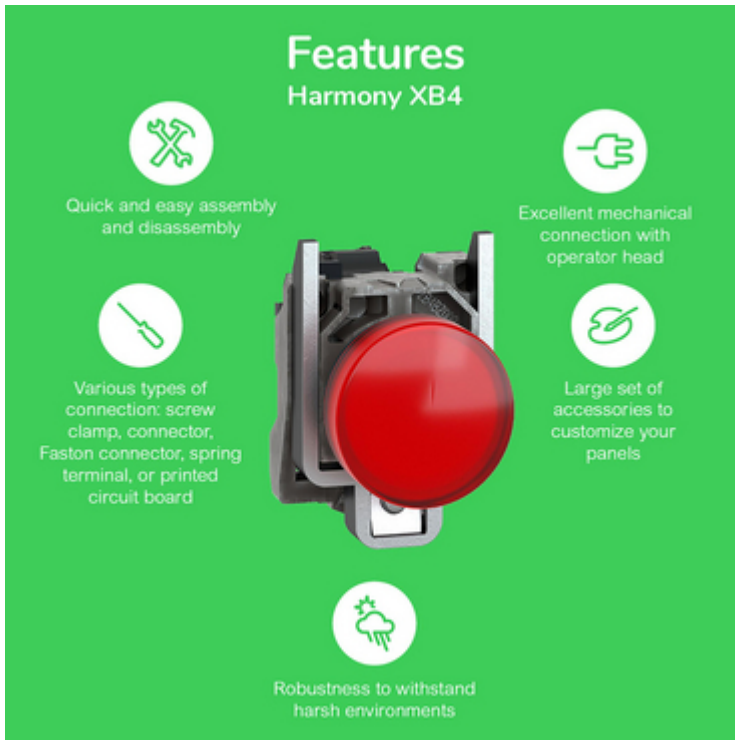

The infographic features a central image of a red Schneider XB4 circuit breaker. It is surrounded by five circular icons, each with a corresponding text description of a feature. The background is a solid green color.

### Features Harmony XB4





-  Quick and easy assembly and disassembly
-  Various types of connection: screw clamp, connector, Faston connector, spring terminal, or printed circuit board
-  Excellent mechanical connection with operator head
-  Large set of accessories to customize your panels
-  Robustness to withstand harsh environments

Image of product / Alternate images

Alternative

---

