

Product datasheet

Specifications



Head for illuminated selector switch, Harmony XB4, chromium metal, white handle, 22mm, universal LED, 3 positions

Local distributor code:
237118419

ZB4BK1313

Important message: A change in appearance may be noted on the product but does not affect its use in terms of function and safety. This makes it compatible with our Universal LED blocks
EAN Code: 3389110890709

Main

Range of product	Harmony XB4
Product or component type	Head for illuminated selector switch
Product compatibility	Universal LED
Device short name	ZB4
Bezel material	Chromium plated metal
Head type	Standard
Mounting diameter	22 mm
Sale per indivisible quantity	1
Shape of signaling unit head	Round
Type of operator	stay put
Operator profile	White standard handle
Operator position information	3 positions +/- 45°

Complementary

CAD overall width	29 mm
CAD overall height	29 mm
CAD overall depth	43 mm
Net weight	0.036 kg
Resistance to high pressure washer	7000000 Pa at 55 °C, distance : 0.1 m
Mechanical durability	500000 cycles
Electrical composition code	M3 for <4 contacts using single blocks in front mounting with integral LED M6 for <2 contacts using single blocks in front mounting with integral LED and transformer M10 for <2 contacts using single blocks in front mounting with integral LED M4 for <4 contacts using single and double blocks in front mounting with integral LED
Device presentation	Basic element

Environment

Protective treatment	TH
Ambient air temperature for storage	-40...70 °C
Ambient air temperature for operation	-40...70 °C

Overvoltage category	Class I conforming to IEC 60536
IP degree of protection	IP66 conforming to IEC 60529 IP67 IP69 IP69K
NEMA degree of protection	NEMA 13 NEMA 4X
IK degree of protection	IK04 conforming to IEC 50102
Standards	CSA C22.2 No 14 JIS C8201-5-1 IEC 60947-1 IEC 60947-5-1 IEC 60947-5-5 IEC 60947-5-4 UL 508 JIS C8201-1
Product certifications	CSA DNV BV LROS (Lloyds register of shipping) UL listed
Vibration resistance	5 gn (f= 2...500 Hz) conforming to IEC 60068-2-6
Shock resistance	30 gn (duration = 18 ms) for half sine wave acceleration conforming to IEC 60068-2-27 50 gn (duration = 11 ms) for half sine wave acceleration conforming to IEC 60068-2-27

Packing Units

Unit Type of Package 1	PCE
Number of Units in Package 1	1
Package 1 Height	3.3 cm
Package 1 Width	5 cm
Package 1 Length	5.2 cm
Package 1 Weight	41 g
Unit Type of Package 2	BB1
Number of Units in Package 2	5
Package 2 Height	5 cm
Package 2 Width	3.3 cm
Package 2 Length	26.4 cm
Package 2 Weight	205 g
Unit Type of Package 3	S02
Number of Units in Package 3	100
Package 3 Height	15 cm
Package 3 Width	30 cm
Package 3 Length	40 cm
Package 3 Weight	4.4 kg

Logistical informations

Country of origin	FR
--------------------------	----

Contractual warranty

Warranty (in months)

18



Environmental Data

Schneider Electric aims to achieve Net Zero status by 2050 through supply chain partnerships, lower impact materials, and circularity via our ongoing “Use Better, Use Longer, Use Again” campaign to extend product lifetimes and recyclability.

[Environmental Data explained >](#)

[How we assess product sustainability >](#)

Environmental footprint

Total lifecycle Carbon footprint	1
----------------------------------	---

Environmental Disclosure	Product Environmental Profile
--------------------------	---

Use Better

Materials and Substances

Packaging made with recycled cardboard	No
--	----

Packaging without single use plastic	No
--------------------------------------	----

EU RoHS Directive	Pro-active compliance (Product out of EU RoHS legal scope)
-----------------------------------	--

REACH Regulation	REACH Declaration
------------------	-----------------------------------

Use Again

Repack and remanufacture

End of life manual availability	End of Life Information
---------------------------------	---

Take-back	No
-----------	----

Dimensions Drawings

Dimensions

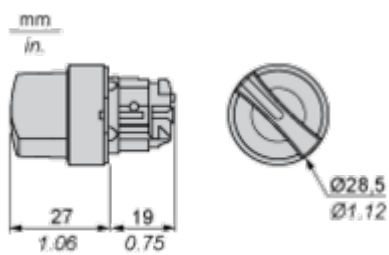

Mounting and Clearance

Panel Cut-out for Pushbuttons, Switches and Pilot Lights (Finished Holes, Ready for Installation)

Connection by Screw Clamp Terminals or Plug-in Connectors or on Printed Circuit Board	Connection by Faston Connectors
	
<p>(1) Diameter on finished panel or support (2) 40 mm min. / 1.57 in. min. (3) 30 mm min. / 1.18 in. min. (4) $\varnothing 22.5 \text{ mm} / 0.89 \text{ in. recommended } (\varnothing 22.3 \text{ mm }_0^{+0.4} / 0.88 \text{ in. }_0^{+0.016})$ (5) 45 mm min. / 1.78 in. min. (6) 32 mm min. / 1.26 in. min.</p>	

Pushbuttons, Switches and Pilot Lights for Printed Circuit Board Connection

Panel Cut-outs (Viewed from Installer's Side)

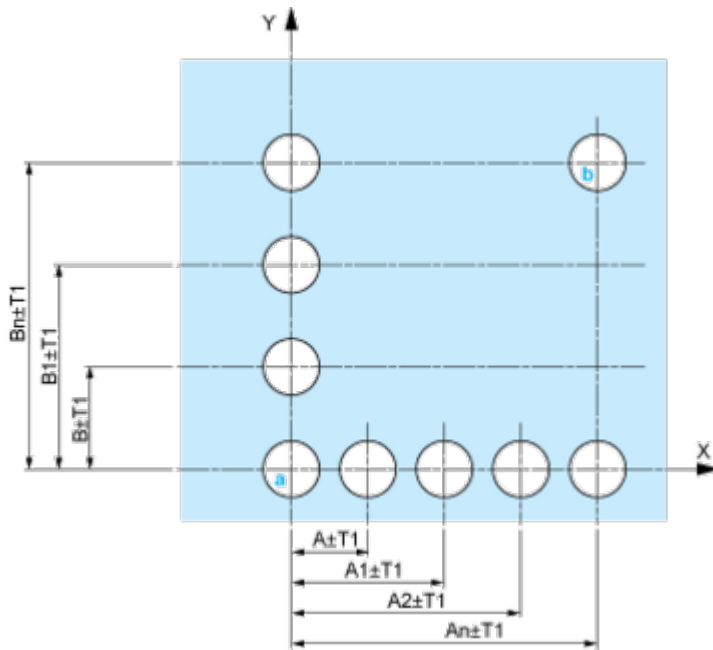

A: 30 mm min. / 1.18 in. min.
 B: 40 mm min. / 1.57 in. min.

Printed Circuit Board Cut-outs (Viewed from Electrical Block Side)

Dimensions in mm

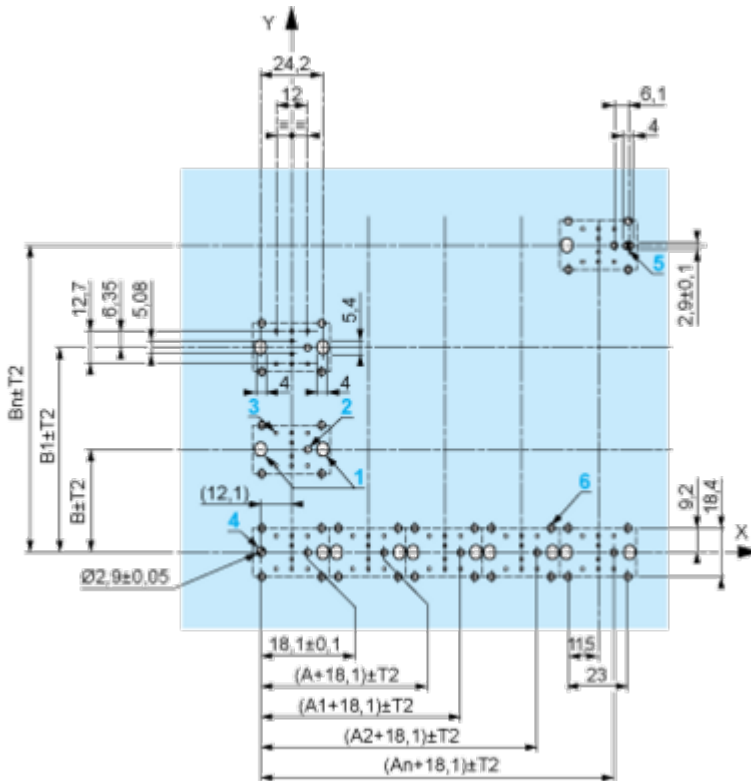

A: 30 mm min.
 B: 40 mm min.
 Dimensions in in.

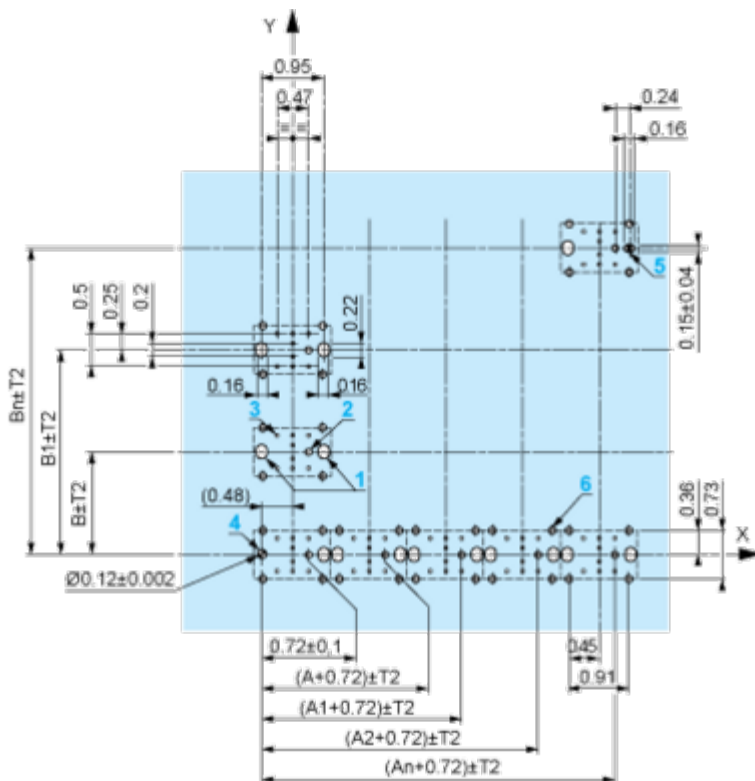

A: 1.18 in. min.
 B: 1.57 in. min.

General Tolerances of the Panel and Printed Circuit Board

The cumulative tolerance must not exceed 0.3 mm / 0.012 in: T1 + T2 = 0.3 mm max.

Installation Precautions

- Minimum thickness of circuit board: 1.6 mm / 0.06 in.
- Cut-out diameter: 22.4 mm ± 0.1 / 0.88 in. ± 0.004
- Orientation of body/fixing collar ZB4 BZ009: ± 2° 30' (excluding cut-outs marked a and b).
- Tightening torque of screws ZBZ 006: 0.6 N.m (5.3 lbf.in) max.
- Allow for one ZB4 BZ079 fixing collar/pillar and its fixing screws:
 - every 90 mm / 3.54 in. horizontally (X), and 120 mm / 4.72 in. vertically (Y).
 - with each selector switch head (ZB4 BD*, ZB4 BJ*, ZB4 BG*).

The fixing centers marked a and b are diagonally opposed and must align with those marked 4 and 5.



(1) Panel

(2) Printed circuit board

Mounting of Adapter (Socket) ZBZ 01•

- 1 2 elongated holes for ZBZ 006 screw access
- 2 1 hole Ø 2.4 mm ± 0.05 / 0.09 in. ± 0.002 for centring adapter ZBZ 01•
- 3 8 × Ø 1.2 mm / 0.05 in. holes
- 4 1 hole Ø 2.9 mm ± 0.05 / 0.11 in. ± 0.002, for aligning the printed circuit board (with cut-out marked a)
- 5 1 elongated hole for aligning the printed circuit board (with cut-out marked b)
- 6 4 holes Ø 2.4 mm / 0.09 in. for clipping in adapter ZBZ 01•

Dimensions An + 18.1 relate to the Ø 2.4 mm ± 0.05 / 0.09 in. ± 0.002 holes for centring adapter ZBZ 01•.

Technical Description

Electrical Composition Corresponding to Code M3

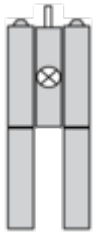

Electrical Composition Corresponding to Code M4

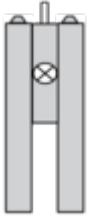

Electrical Composition Corresponding to Codes M6 and P2



Electrical Composition Corresponding to Codes M5, M10, MF1, MR1 and MF2



Legend

Single contact



Double contact



Light block



Possible location



Sequence of Contacts Fitted to 3-position Selector Switch Body

Position 315°



Push	Position	Top			
		Bottom			
	Location		Left		Right
	State		1		0
Contacts	N/O		closed	open	
	N/C		open	closed	

Position 0°



Push	Position	Top			
		Bottom			
	Location		Left		Right
	State		0		0
Contacts	N/O		open	open	
	N/C		closed	closed	

Position 45°



Push	Position	Top			
		Bottom			
	Location		Left		Right
	State		0		1
	Contacts	N/O			open
N/C		closed	open		

Technical Illustration

Dimensions

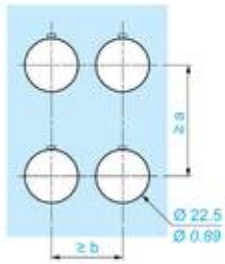
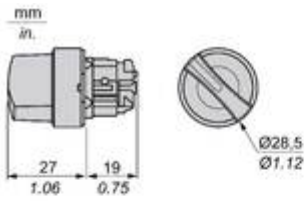

		a (mm)	a (in.)	b (mm)	b (in.)
		40	1.57	30	1.18
ZBE.....	ZBV.....				
		45	1.77	32	1.26
ZBE.....3	ZBV.....3				
		40	1.57	30	1.18
ZBE.....4	ZBV.....4				
		50	1.97	30	1.18
ZBE.....5	ZBV.....5				
		40	1.57	30	1.18
ZBE.....9	ZBV.....9				
		40	1.57	30	1.18
ZBRT•	ZBRV1				

Offer Marketing Illustration

Product benefits / Features

Technical Benefits

Harmony XB4

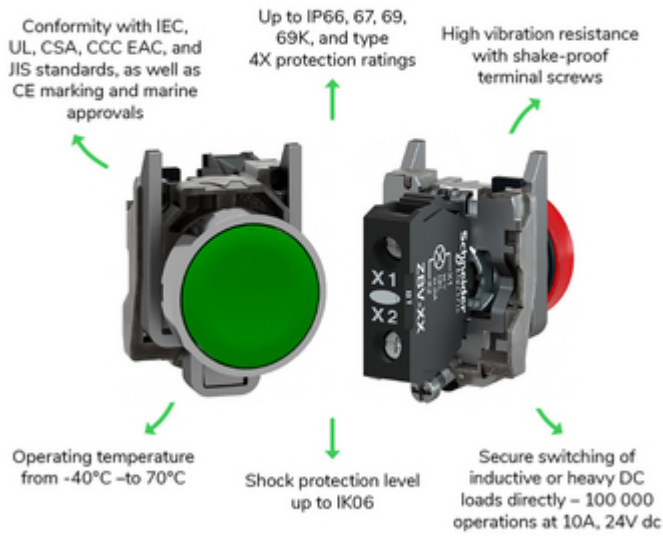

Offer Marketing Illustration

Product benefits / Features

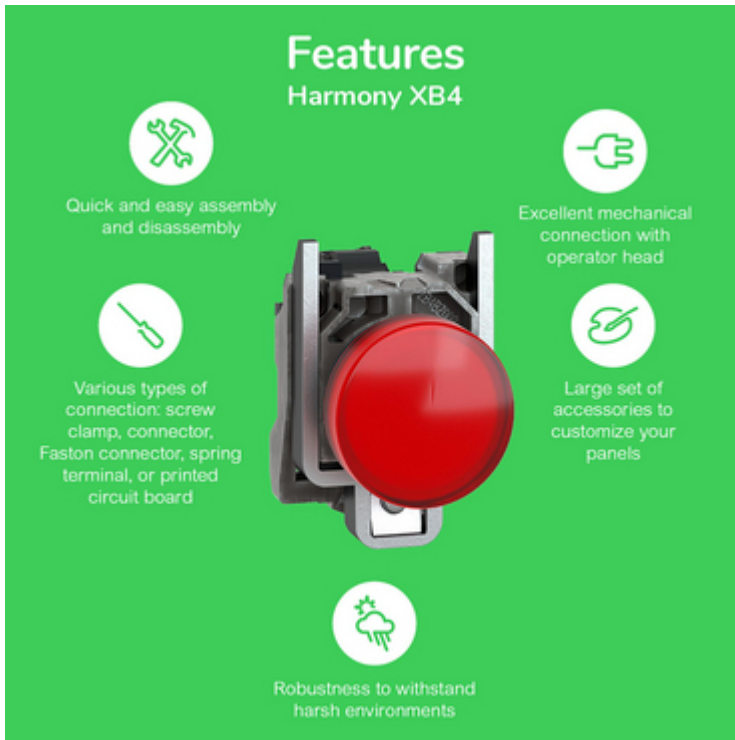

The infographic features a central image of a red Schneider XB4 circuit breaker. It is surrounded by five circular icons, each with a corresponding text description of a feature. The background is a solid green color.

Features Harmony XB4

- Quick and easy assembly and disassembly** (Icon: crossed wrench and screwdriver)
- Excellent mechanical connection with operator head** (Icon: hand holding a plug)
- Large set of accessories to customize your panels** (Icon: plug with a slash)
- Robustness to withstand harsh environments** (Icon: lightning bolt and rain cloud)
- Various types of connection: screw clamp, connector, Faston connector, spring terminal, or printed circuit board** (Icon: screwdriver)

Image of product / Alternate images

Alternative

