

switch disconnecter with fuse 400 A, frame size 4, 3-pole for LV HRC fuse size 1 and 2 front operating mechanism left complete unit with direct operating mechanism flat connector without fuses

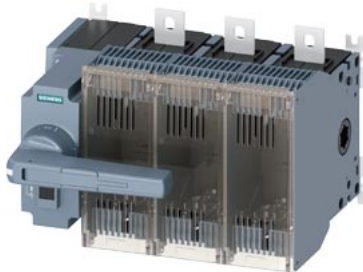

Model	
product brand name	SENTRON
product designation	3KF switch disconnecter with fuses
design of the product	3KF switch disconnecter with fuses
product version	3KF NH
design of the actuating element	manual operating mechanism
design of handle	Direct operating mechanism, gray
direction of actuation	from the front
type of the driving mechanism motor drive	No
number of poles	3
size of disconnecting link	2 and 1
size of switch disconnecter	4
size of fuse link	NH1, NH2
mechanical service life (operating cycles) typical	8 000
electrical endurance (operating cycles)	
• at AC-23 A at 440 V	3 000
• at AC-23 A at 690 V	2 000
• at DC-23 A at 440 V	1 000
I ² t value	
• with closed switch for combination switch + fuse at 500 V maximum	1 205 000 A ² ·s
• with closed switch for combination switch + fuse at 400 V maximum	1 205 000 A ² ·s
• with closed switch at 690 V for combination switch + gG fuse maximum	1 300 000 A ² ·s
• of the fuse at 500 V maximum permissible	2 150 000 A ² ·s
• of the gG fuse at 690 V maximum permissible	2 600 000 A ² ·s
• of the aM fuse at 690 V maximum permissible	2 600 000 A ² ·s
position of the switch operating mechanism	left
fuse system	LV HRC fuse
overvoltage category	IV
operating voltage with current paths in series	
• with degree of pollution 2 at DC rated value	440 / 3
• with degree of pollution 3 at DC rated value	440 / 3
surge voltage resistance rated value	12 kV
Supply voltage	
operating voltage at AC rated value maximum	690 V
Protection class	
protection class IP	IP00
protection class IP	

- with closed switch with cover or cable lug cover IP20
- on the front IP00

Dissipation

power loss [W]

- with conventional rated thermal current per pole 26 W
- with conventional rated thermal current per device 78 W
- with conventional rated thermal current without fuse per pole 26 W
- with conventional rated thermal current without fuse per device 78 W
- for rated value of the current at AC in hot operating state per pole 26 W
- of the fuse per fuse maximum 34 W

Main circuit

- operating power at AC-23 A at 500 V rated value 280 kW
- operational current rated value 400 A

Auxiliary circuit

- number of connected NC contacts for auxiliary contacts** 0
- number of connected NO contacts for auxiliary contacts** 0
- number of connected CO contacts for auxiliary contacts** 0
- number of CO contacts for auxiliary contacts 0
- number of NC contacts for auxiliary contacts** 8
- number of NO contacts for auxiliary contacts** 8
- suitability for use main switch** Yes
- suitability for use switch disconnecter** Yes
- suitability for use EMERGENCY OFF switch** No
- suitability for use safety switch** Yes
- suitability for use maintenance/repair switch** Yes
- product feature interlock** Yes
- product function phase failure monitoring** No
- product component**
 - voltage trigger No
 - undervoltage release No
 - undervoltage release with leading contact No
- product feature sealable** Yes
- product extension auxiliary switch** Yes
- product extension optional locking capability** No
- product extension optional motor drive** No
- product extension optional fuse monitoring** Yes
- product function**
 - fuse monitoring No
 - overvoltage protection monitoring No

Short circuit

- short-circuit current making capacity (I_{cm}) for switch disconnecter at 690 V AC/440 V DC without fuse link rated value minimum 24 kA
- conditional short-circuit current with line-side fuse protection**
 - at 500 V by gG fuse rated value 100 kA
 - at 690 V by gG fuse rated value 100 kA

Connections

- arrangement of electrical connectors for main current circuit Top and bottom
- tightening torque with screw-type terminals**
 - minimum 30 N·m
 - maximum 44 N·m
- type of connectable conductor cross-sections for aluminum conductor stranded with lug 1x (6 ... 240 mm²), 2x (6 ... 150 mm²)
- type of connectable conductor cross-sections**
 - for copper busbar 1x (30 x 10 mm²)
- type of connectable conductor cross-sections for copper conductor**

<ul style="list-style-type: none"> • stranded with lug according to DIN 46234 	1x (6 ... 240 mm ²), 2x (6 ... 150 mm ²)
<ul style="list-style-type: none"> • stranded with lug according to DIN 46235 	1x (16 ... 185 mm ²), 2x (16 ... 150 mm ²)
type of electrical connection for main current circuit	flat connector

Mechanical Design

height	215 mm
width	291 mm
depth	269.6 mm
fastening method	floor mounting
fastening method	
<ul style="list-style-type: none"> • 4-hole front mounting 	No
<ul style="list-style-type: none"> • front mounting with central attachment 	No
<ul style="list-style-type: none"> • rail mounting 	No
mounting position	any
Net Weight	8.12 kg

Environmental conditions

ambient temperature during operation	
<ul style="list-style-type: none"> • minimum 	-25 °C
<ul style="list-style-type: none"> • maximum 	70 °C
ambient temperature during storage	
<ul style="list-style-type: none"> • minimum 	-50 °C
<ul style="list-style-type: none"> • maximum 	80 °C

Approvals Certificates

General Product Approval



[Confirmation](#)



[Miscellaneous](#)

General Product Approval	Test Certificates	Maritime application	other
--------------------------	-------------------	----------------------	-------



[Type Test Certificates/Test Report](#)



[Confirmation](#)

[Miscellaneous](#)

Environment

[Environmental Confirmations](#)

[Environmental Confirmations](#)

Further information

Information on the packaging

<https://support.industry.siemens.com/cs/ww/en/view/109813875>

Information for data generation and storage

<https://support.industry.siemens.com/cs/ww/en/view/109995012>

Information- and Downloadcenter (Catalogs, Brochures,...)

<https://www.siemens.com/lowvoltage/catalogs>

Industry Mall (Online ordering system)

<https://mall.industry.siemens.com/mall/en/en/Catalog/product?mlfb=3KF4340-2LF11>

Service&Support (Manuals, Certificates, Characteristics, FAQs,...)

<https://support.industry.siemens.com/cs/ww/en/ps/3KF4340-2LF11>

Image database (product images, 2D dimension drawings, 3D models, device circuit diagrams, ...)

https://www.automation.siemens.com/bilddb/cax_en.aspx?mlfb=3KF4340-2LF11

CAX-Online-Generator

<https://www.siemens.com/cax>

Tender specifications

<https://www.siemens.com/specifications>

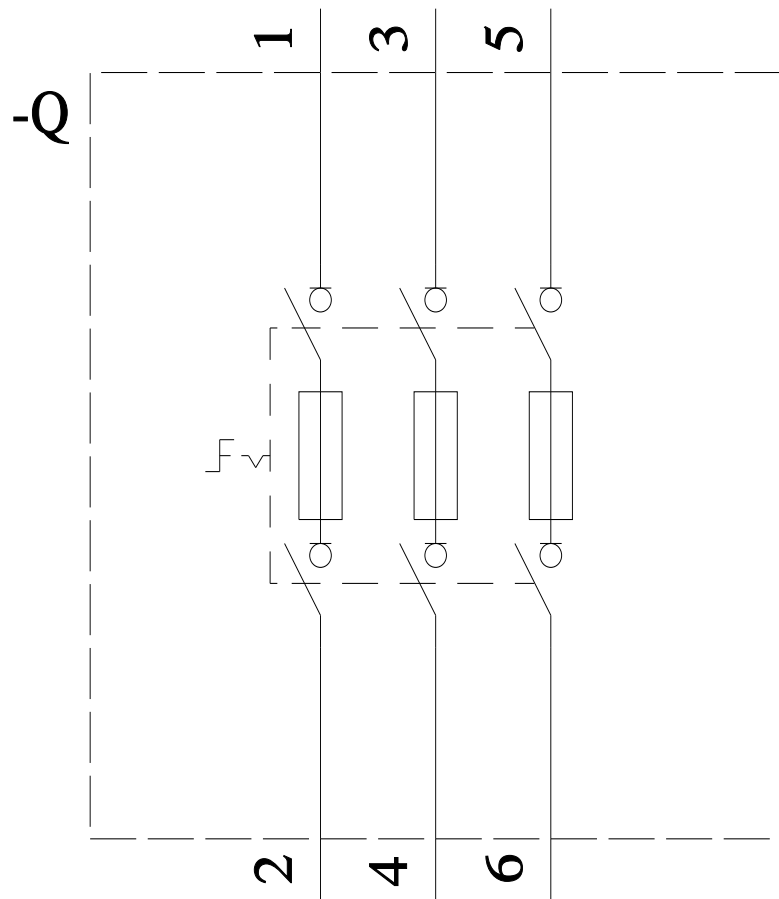
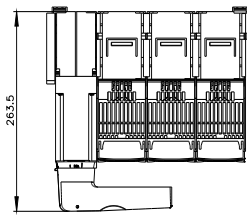
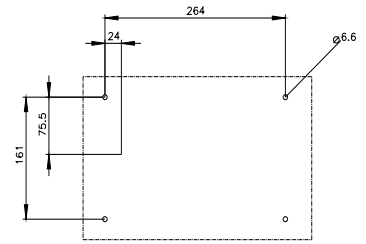
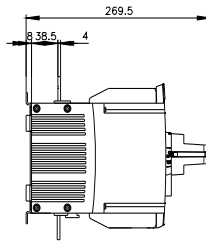
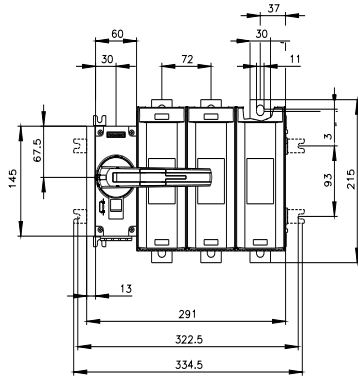

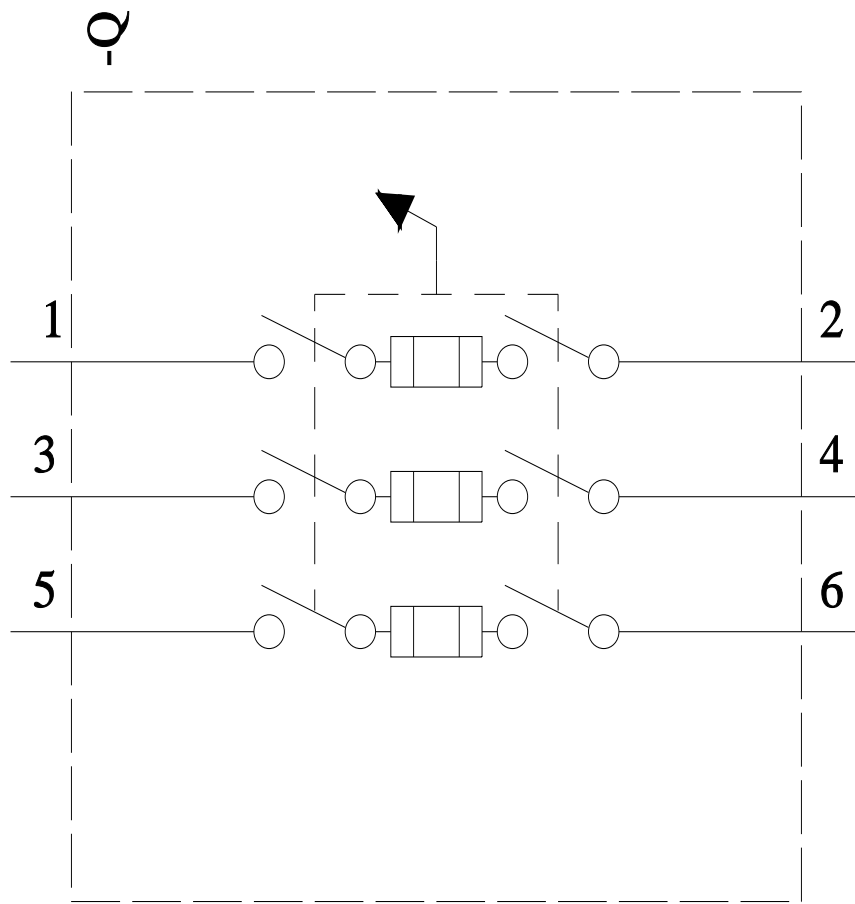

last modified:

4/3/2025 