

C41E-0401AG300

C4000 Micro

SAFETY LIGHT CURTAINS

SICK
Sensor Intelligence.

Illustration may differ

Ordering information

Type	part no.
C41E-0401AG300	1023461

Other models and accessories → www.sick.com/C4000_Micro

Detailed technical data

Features

System part	Receiver
Resolution	14 mm
Scanning range	2.5 m
Protective field height	450 mm
Synchronization	Optical synchronization

Safety-related parameters

Type	Type 4 (IEC 61496-1)
Safety integrity level	SIL 3 (IEC 61508)
Category	Category 4 (EN ISO 13849)
Performance level	PL e (EN ISO 13849)
PFH_D (mean probability of a dangerous failure per hour)	15×10^{-9} (EN ISO 13849)
T_M (mission time)	20 years (EN ISO 13849)
Safe state in the event of a fault	At least one OSSD is in the OFF state.

Functions

	Functions	Delivery status
Protective operation	✓	
Restart interlock	✓	Internal
External device monitoring (EDM)	✓	Deactivated

Interfaces

System connection	
Direction of cable connection	Straight
Conductor cross section	0.25 mm ²
Permitted cable length	15 m ¹⁾
Configuration method	Hard wired
Display elements	7-segment display

¹⁾ Depending on load, power supply and wire cross-section. The technical specifications must be observed.

Electronics

Protection class	III (IEC 61140)
Supply voltage V_S	24 V DC (19.2 V ... 28.8 V) ¹⁾
Residual ripple	$\leq 10\%$ ²⁾
Output signal switching devices (OSSDs)	
Type of output	2 PNP semiconductors, short-circuit protected, cross-circuit monitored
ON state, switching voltage HIGH	24 V DC (15 V DC ... 28.8 V DC)
OFF state, switching voltage LOW	2 V DC
Current-carrying capacity per OSSD	≤ 500 mA

¹⁾ The external voltage supply must be capable of buffering brief mains voltage failures of 20 ms as specified in EN 60204-1. Suitable power supplies are available as accessories from SICK.

²⁾ Within the limits of V_S .

Mechanics

Dimensions	See dimensional drawing
Housing cross-section	33.5 mm x 28.5 mm
Housing material	Aluminum extruded profile
Weight	525 g

Ambient data

Enclosure rating	IP65 (IEC 60529)
Ambient operating temperature	-30 °C ... +55 °C
Storage temperature	-30 °C ... +70 °C
Air humidity	15 % ... 95 %, Non-condensing
Vibration resistance	5 g, 10 Hz ... 55 Hz (EN 60068-2-6)
Shock resistance	10 g, 16 ms (EN 60068-2-27)

Other information

Wave length	850 nm
--------------------	--------

Classifications

ECLASS 5.0	27272704
ECLASS 5.1.4	27272704
ECLASS 6.0	27272704
ECLASS 6.2	27272704
ECLASS 7.0	27272704
ECLASS 8.0	27272704
ECLASS 8.1	27272704
ECLASS 9.0	27272704
ECLASS 10.0	27272704
ECLASS 11.0	27272704
ECLASS 12.0	27272704
ETIM 5.0	EC002549
ETIM 6.0	EC002549

ETIM 7.0	EC002549
ETIM 8.0	EC002549
UNSPSC 16.0901	46171620

Dimensional drawing

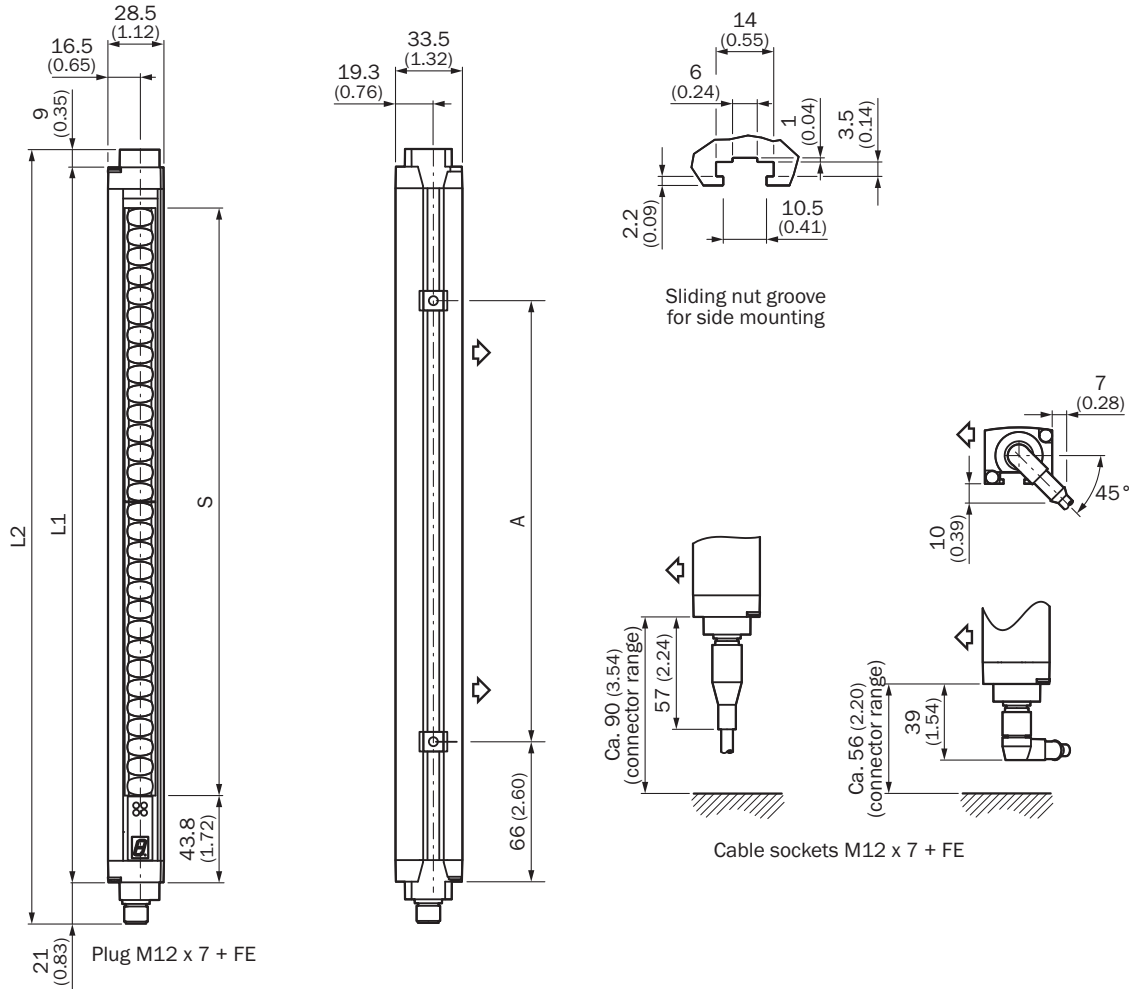



Dimensions in mm (inch)
illustration sender (receiver mirror image)



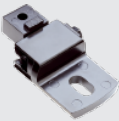

Protective field height S	L1	L2	A
150 (5.91)	246 (9.69)	276 (10.87)	106 (4.17)
300 (11.81)	364 (14.33)	394 (15.51)	224 (8.82)
450 (17.72)	515 (20.28)	545 (21.46)	374 (14.72)
600 (23.62)	666 (26.22)	696 (27.40)	524 (20.639)
750 (29.53)	816 (32.13)	846 (33.31)	674 (26.54)
900 (35.43)	967 (38.07)	997 (39.25)	824 (32.44)
1,050 (41.34)	1,117 (43.98)	1,147 (45.16)	974 (38.35)
1,200 (47.24)	1,266 (49.84)	1,296 (51.02)	1,124 (44.25)

Recommended accessories

Other models and accessories → www.sick.com/C4000_Micro

	Brief description	Type	part no.
device protection and care			
	<ul style="list-style-type: none"> Product family: Cleaning agents Description: Cloth for cleaning optical surfaces 	Lens cloth	4003353
Mounting systems			
	<ul style="list-style-type: none"> Description: Mounting kit 6, side bracket, rotatable Material: Zinc diecast Details: Zinc diecast Packing unit: 4 pieces Suitable for: All protective field heights 	BEF-1SHABAZN4	2019506
Commissioning aids and test equipment			
	<ul style="list-style-type: none"> Product: Alignment aids Dimensions (W x H x L): 19 mm 67.3 mm 66.9 mm Description: Laser alignment aid for various sensors, laser class 2 (IEC 60825). Do not look into the beam! 	AR60	1015741
	<ul style="list-style-type: none"> Product: Alignment aids Description: Adapter AR60 for housing cross-section 34 mm x 29 mm 	AR60 adapter, 34x29	4032462

	Brief description	Type	part no.
connectors and cables			
	<ul style="list-style-type: none"> • Connection type head A: Female connector, M12, 8-pin, angled • Connection type head B: Flying leads • Cable: 7.5 m, 8-wire, PUR, halogen-free • Description: Shielded • Connection systems: Flying leads 	DOL-127SW7M5E25KMO	6034783
	<ul style="list-style-type: none"> • Connection type head A: Female connector, M12, 8-pin, angled • Connection type head B: Flying leads • Signal type: Sensor/actuator cable • Cable: 7.5 m, 7-wire, PUR, halogen-free • Description: Sensor/actuator cable, shielded • Connection systems: Flying leads 	DOL-127SW7M5E25KMO	2076549
	<ul style="list-style-type: none"> • Connection type head A: Female connector, M12, 8-pin, straight • Connection type head B: Flying leads • Cable: 5 m, PUR, halogen-free • Description: Shielded • Connection systems: Flying leads 	DOL-127SG05ME25KMO	6020354
	<ul style="list-style-type: none"> • Connection type head A: Female connector, M12, 8-pin, angled • Connection type head B: Flying leads • Cable: 15 m, PUR, halogen-free • Description: Shielded • Connection systems: Flying leads 	DOL-127SW15ME25KMO	6021343
	<ul style="list-style-type: none"> • Connection type head A: Female connector, M12, 8-pin, angled • Connection type head B: Flying leads • Cable: 5 m, PUR, halogen-free • Description: Shielded • Connection systems: Flying leads 	DOL-127SW05ME25KMO	6021342
	<ul style="list-style-type: none"> • Connection type head A: Female connector, M12, 8-pin, straight • Connection type head B: Flying leads • Cable: 7.5 m, PUR, halogen-free • Description: Shielded • Connection systems: Flying leads 	DOL-127SG7M5E25KMO	6020353
	<ul style="list-style-type: none"> • Connection type head A: Female connector, M12, 8-pin, straight • Connection type head B: Flying leads • Cable: 2.5 m, PUR, halogen-free • Description: Shielded • Connection systems: Flying leads 	DOL-127SG2M5E25KMO	6020537
	<ul style="list-style-type: none"> • Connection type head A: Female connector, M12, 8-pin, straight • Connection type head B: Flying leads • Cable: 15 m, PUR, halogen-free • Description: Shielded • Connection systems: Flying leads 	DOL-127SG15ME25KMO	6020872
	<ul style="list-style-type: none"> • Connection type head A: Female connector, M12, 8-pin, straight • Connection type head B: Flying leads • Cable: 10 m, PUR, halogen-free • Description: Shielded • Connection systems: Flying leads 	DOL-127SG10ME25KMO	6020352
	<ul style="list-style-type: none"> • Connection type head A: Female connector, M12, 8-pin, straight • Connection type head B: Flying leads • Signal type: Sensor/actuator cable • Cable: 5 m, 7-wire, PUR, halogen-free • Description: Sensor/actuator cable, shielded • Connection systems: Flying leads 	DOL-127SG05ME25KMO	2076541
	<ul style="list-style-type: none"> • Connection type head A: Female connector, M12, 8-pin, angled • Connection type head B: Flying leads • Signal type: Sensor/actuator cable • Cable: 15 m, 7-wire, PUR, halogen-free • Description: Sensor/actuator cable, shielded • Connection systems: Flying leads 	DOL-127SW15ME25KMO	2076551
	<ul style="list-style-type: none"> • Connection type head A: Female connector, M12, 8-pin, angled • Connection type head B: Flying leads • Signal type: Sensor/actuator cable • Cable: 5 m, 7-wire, PUR, halogen-free • Description: Sensor/actuator cable, shielded 	DOL-127SW05ME25KMO	2076548

	Brief description	Type	part no.
	<ul style="list-style-type: none"> • Connection systems: Flying leads • Connection type head A: Female connector, M12, 8-pin, straight • Connection type head B: Flying leads • Signal type: Sensor/actuator cable • Cable: 7.5 m, 7-wire, PUR, halogen-free • Description: Sensor/actuator cable, shielded • Connection systems: Flying leads 	DOL-127SG7M5E25KMC	2076542
	<ul style="list-style-type: none"> • Connection type head A: Female connector, M12, 8-pin, straight • Connection type head B: Flying leads • Signal type: Sensor/actuator cable • Cable: 2.5 m, 7-wire, PUR, halogen-free • Description: Sensor/actuator cable, shielded • Connection systems: Flying leads 	DOL-127SG2M5E25KMC	2076540
	<ul style="list-style-type: none"> • Connection type head A: Female connector, M12, 8-pin, straight • Connection type head B: Flying leads • Signal type: Sensor/actuator cable • Cable: 15 m, 7-wire, PUR, halogen-free • Description: Sensor/actuator cable, shielded • Connection systems: Flying leads 	DOL-127SG15ME25KMC	2076544
	<ul style="list-style-type: none"> • Connection type head A: Female connector, M12, 8-pin, straight, A-coded • Connection type head B: Flying leads • Signal type: Sensor/actuator cable • Cable: 10 m, 7-wire, PUR, halogen-free • Description: Sensor/actuator cable, shielded • Connection systems: Flying leads 	DOL-127SG10ME25KMC	2076543

SICK AT A GLANCE

SICK is one of the leading manufacturers of intelligent sensors and sensor solutions for industrial applications. A unique range of products and services creates the perfect basis for controlling processes securely and efficiently, protecting individuals from accidents and preventing damage to the environment.

We have extensive experience in a wide range of industries and understand their processes and requirements. With intelligent sensors, we can deliver exactly what our customers need. In application centers in Europe, Asia and North America, system solutions are tested and optimized in accordance with customer specifications. All this makes us a reliable supplier and development partner.

Comprehensive services complete our offering: SICK LifeTime Services provide support throughout the machine life cycle and ensure safety and productivity.

For us, that is “Sensor Intelligence.”

WORLDWIDE PRESENCE:

Contacts and other locations –www.sick.com