

Product datasheet

Specifications



Head for non illuminated push button, Harmony XB4, flush mounted green flush caps pushbutton white marked "ON"

Local distributor code:

407814608

ZB4FA341

EAN Code: 3606489581015

Main

Range of product	Harmony XB4
Product or component type	Head for non-illuminated push-button
Device short name	ZB4F
Bezel material	Chromium plated metal
Mounting diameter	30.5 mm
Sale per indivisible quantity	1
Head type	Built-in-flush
Shape of signaling unit head	Round
Type of operator	spring return
Operator profile	Green flush, ON (white)
Cap/operator or lens colour	Green

Complementary

CAD overall width	36.6 mm
CAD overall height	36.6 mm
CAD overall depth	31 mm
Mechanical durability	10000000 cycles
Electrical composition code	C1 for <9 contacts using single blocks in front mounting C2 for <9 contacts using single and double blocks in front mounting C11 for <3 contacts using single blocks in front mounting C15 for <1 contacts using single blocks in front mounting
Device presentation	Basic element

Environment

Protective treatment	TH
Ambient air temperature for storage	-40...70 °C
Ambient air temperature for operation	-40...70 °C
Overvoltage category	Class I conforming to IEC 60536
IP degree of protection	IP66 conforming to IEC 60529 IP67 conforming to IEC 60529 IP69 conforming to IEC 60529 IP69K conforming to ISO 20653 Type 13 conforming to UL 50E Type 12 conforming to UL 50E Type 4 conforming to UL 50E Type 4X conforming to UL 50E

IK degree of protection	IK06 conforming to IEC 50102
Standards	CSA C22.2 No 14 IEC 60947-5-1 IEC 60947-5-4 UL 508 IEC 60947-1 JIS C8201-5-1 CE JIS C8201-1
Product certifications	UL listed CSA CCC EAC
Vibration resistance	5 gn (f= 10...500 Hz) conforming to IEC 60068-2-6 25 mm peak to peak (f= 2...10 Hz) conforming to IEC 60068-2-6
Shock resistance	30 gn (duration = 18 ms) for half sine wave acceleration conforming to IEC 60068-2-27 50 gn (duration = 11 ms) for half sine wave acceleration conforming to IEC 60068-2-27 25 gn (duration = 6 ms) for 1000 shocks on each axis conforming to IEC 60068-2-27

Packing Units

Unit Type of Package 1	PCE
Number of Units in Package 1	1
Package 1 Height	4.300 cm
Package 1 Width	5.300 cm
Package 1 Length	5.700 cm
Package 1 Weight	58.000 g

Logistical informations

Country of origin	FR
--------------------------	----

Contractual warranty

Warranty (in months)	18
-----------------------------	----



Environmental Data

Schneider Electric aims to achieve Net Zero status by 2050 through supply chain partnerships, lower impact materials, and circularity via our ongoing “Use Better, Use Longer, Use Again” campaign to extend product lifetimes and recyclability.

[Environmental Data explained >](#)

[How we assess product sustainability >](#)



Environmental footprint

Total lifecycle Carbon footprint	0.5 kg CO2 eq.
Carbon footprint of the manufacturing phase [A1 to A3]	0.4 kg CO2 eq.
Carbon footprint of the distribution phase [A4]	0 kg CO2 eq.
Carbon footprint of the installation phase [A5]	0 kg CO2 eq.
Carbon footprint of the use phase [B2, B3, B4, B6]	0 kg CO2 eq.
Carbon footprint of the end-of-life phase [C1 to C4]	0.1 kg CO2 eq.

Use Better



Materials and Substances

Average percentage of recycled plastic content	14 %
Average percentage of recycled metal content	21 %
Packaging made with recycled cardboard	Yes
Packaging without single use plastic	Yes
EU RoHS Directive	Pro-active compliance (Product out of EU RoHS legal scope)
REACH Regulation	REACH Declaration

Use Longer



Lifetime extension

Repair	No
--------	----

Use Again



Repack and remanufacture

End of life manual availability	End of Life Information
Take-back	No

Dimensions Drawings

Dimensions

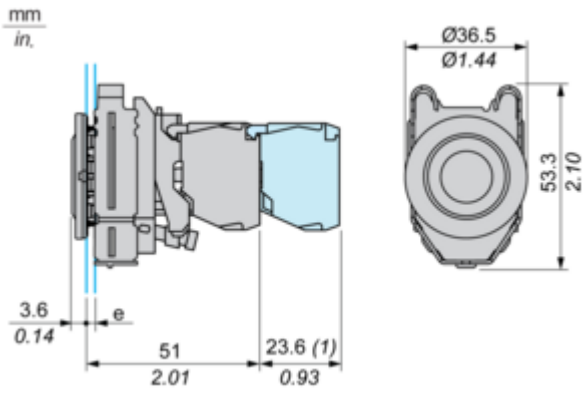

e : clamping thickness: 1 to 6 mm / 0.04 to 0.24 in.
 (1) : Additional row of contacts

Mounting and Clearance

Panel Cut-out for Pushbuttons, Switches and Pilot Lights (Finished Holes, Ready for Installation)

Connection by Screw Clamp Terminals or Plug-in Connectors



(1) : Diameter on finished panel or support

(2) : $\text{Ø}30.75 \text{ mm recommended } (\text{Ø}30.5 \text{ }_0^{+0.5}) / \text{Ø}1.21 \text{ in. recommended } (\text{Ø}1.20 \text{ in. }_0^{+0.0196})$

Connections	a in mm	a in in.	b in mm	b in in.
By connectors	50	1.97	40	1.57
By connectors and with legend holder ZBZF32	50	1.97	40	1.57
By connectors and with legend holder ZBZF33	60	2.36	40	1.57

Technical Description

Electrical Composition Corresponding to Code C1



Electrical Composition Corresponding to Code C2

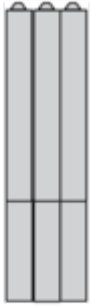

Electrical Composition Corresponding to Codes C9, C11, SF1 and SR1

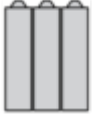

Electrical Composition Corresponding to Code C15

1 N/O



1 N/C



1 N/O + N/C or 1 N/O + N/O or 1 N/C + N/C



Legend

Single contact



Double contact



Light block



Possible location



Technical Illustration

Dimensions

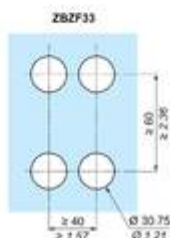
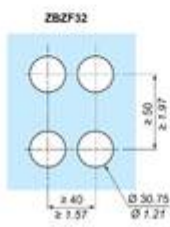
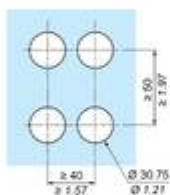
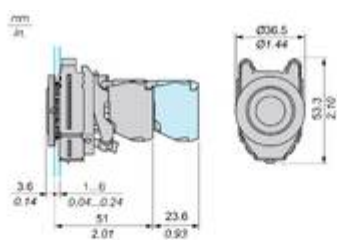

Image of product / Alternate images

Alternative

