

# A-INL-NPT3/4-P-BK - Counter nut



1411238

<https://www.phoenixcontact.com/gb/products/1411238>

Please be informed that the data shown in this PDF document is generated from our online catalog. Please find the complete data in the user documentation. Our general terms of use for downloads are valid.

Counter nut, for threads 3/4"-NPT, color: jet black RAL 9005



## Commercial data

Item number	1411238
Packing unit	5 pc
Minimum order quantity	5 pc
Sales key	AF7DZX
Product key	AF7DZX
GTIN	4046356923699
Weight per piece (including packing)	4.7 g
Weight per piece (excluding packing)	4.54 g
Customs tariff number	39269097
Country of origin	TR

# A-INL-NPT3/4-P-BK - Counter nut

1411238

<https://www.phoenixcontact.com/gb/products/1411238>

## Technical data

### Product properties

Thread type	3/4"-NPT
-------------	----------

### Dimensions

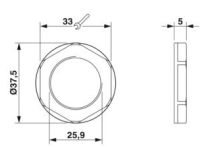
Dimensional drawing	
Length	5 mm
Diameter	25.9 mm
Connecting thread diameter	25.9 mm
Wrench size, counter nut	33 mm
Hexagon angular dimension	37.5 mm
Thread type connection side	3/4"-NPT

### Material specifications

Material	PA
Flammability rating according to UL 94	V2

### Cable/line

Halogen-free	yes
--------------	-----

### Environmental and real-life conditions

#### Ambient conditions

Ambient temperature (operation)	-40 °C ... 100 °C
---------------------------------	-------------------

# A-INL-NPT3/4-P-BK - Counter nut

1411238

<https://www.phoenixcontact.com/gb/products/1411238>



## Drawings

Dimensional drawing

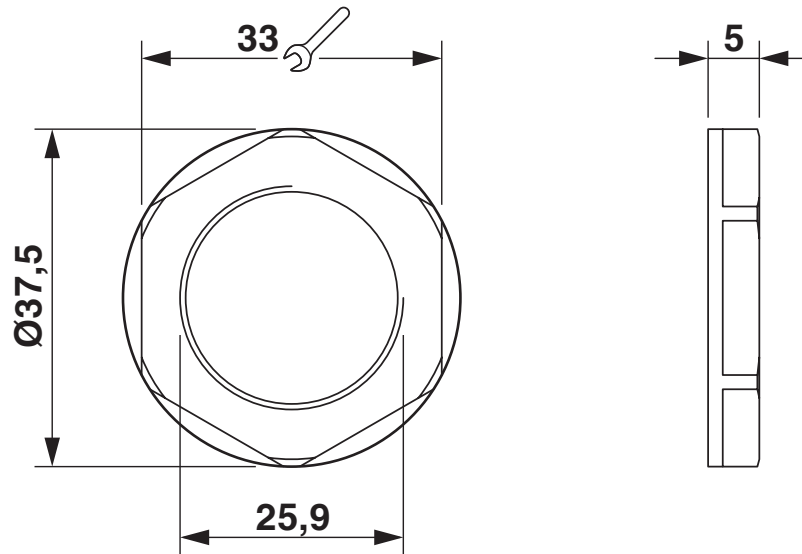

# A-INL-NPT3/4-P-BK - Counter nut



1411238

<https://www.phoenixcontact.com/gb/products/1411238>

## Classifications

### ECLASS

ECLASS-13.0	27140807
ECLASS-15.0	27140807

### ETIM

ETIM 10.0	EC003608
-----------	----------

### UNSPSC

UNSPSC 21.0	31161700
-------------	----------

# A-INL-NPT3/4-P-BK - Counter nut



1411238

<https://www.phoenixcontact.com/gb/products/1411238>

## Environmental product compliance

### EU RoHS

Fulfills EU RoHS substance requirements	Yes, No exemptions
---	--------------------

### China RoHS

Environment friendly use period (EFUP)	EFUP-E
	No hazardous substances above the limits

### EU REACH SVHC

REACH candidate substance (CAS No.)	No substance above 0.1 wt%
-------------------------------------	----------------------------

Phoenix Contact 2026 © - all rights reserved  
<https://www.phoenixcontact.com>

PHOENIX CONTACT Ltd  
Halesfield 13, Telford  
Shropshire, TF7 4PG  
01952 681700  
[info@phoenixcontact.co.uk](mailto:info@phoenixcontact.co.uk)