

Product datasheet

Specifications



Light Module, Harmony XVB7 Modular Tower Light, Yellow, Ø70mm, Blinking, Colored Lens

XVB7C58

EAN Code: 3606487129400

Main

| | |
|---------------------------|--------------------|
| Range of product | Harmony XVB7 |
| Product or component type | Light module |
| Device composition | Standard lens |
| Device short name | XVB7 |
| Mounting diameter | 70 mm |
| Signalling type | Blinking |
| Light color | LED, yellow |
| Material | PC (polycarbonate) |
| Net weight | 0.105 kg |
| Mounting position | Upright/inverted |

Complementary

| | |
|--|--------------------------------------|
| Blinking frequency | 1 Hz |
| Service life in hours | 50000 h |
| [Ue] rated operational voltage | 24 V AC/DC |
| Rated operational voltage limits | 21.6...26.4 V AC/DC |
| Current consumption | 40 mA at 24 V AC 45 mA at 24 V DC |
| Inrush current | 0.5 A |
| Electrical shock protection class | Class II |
| [Ui] rated insulation voltage | 50 V |
| [Uimp] rated impulse withstand voltage | 0.5 kV |

Environment

| | |
|---------------------------------------|---|
| Pollution degree | 2 |
| Ambient air temperature for operation | -25...60 °C |
| Ambient air temperature for storage | -40...70 °C |
| IP degree of protection | IP66 |
| Environmental Type ratings | Type 4/4X/12/13 indoor use only |
| Vibration resistance | 6 gn, amplitude = +/- 0.5 mm (f = 10...500 Hz) in operation |
| Shock resistance | 30 gn (duration = 6 ms) for in operation |

| | |
|-------------------------------|---|
| Standards | UL 60947-5-1 IEC 60947-5-1 CSA C22.2 No 60947-5-1 |
| Product certifications | cULus CCC RCM UKCA CE |

Packing Units

| | |
|-------------------------------------|-----------|
| Unit Type of Package 1 | PCE |
| Number of Units in Package 1 | 1 |
| Package 1 Height | 6.500 cm |
| Package 1 Width | 7.300 cm |
| Package 1 Length | 7.500 cm |
| Package 1 Weight | 105.000 g |
| Unit Type of Package 2 | S03 |
| Number of Units in Package 2 | 60 |
| Package 2 Height | 30 cm |
| Package 2 Width | 30 cm |
| Package 2 Length | 40 cm |
| Package 2 Weight | 6.782 kg |

Contractual warranty

| | |
|-----------------------------|----|
| Warranty (in months) | 18 |
|-----------------------------|----|



Environmental Data

Schneider Electric aims to achieve Net Zero status by 2050 through supply chain partnerships, lower impact materials, and circularity via our ongoing “Use Better, Use Longer, Use Again” campaign to extend product lifetimes and recyclability.

[Environmental Data explained >](#)

[How we assess product sustainability >](#)



Environmental footprint

| | |
|--|---|
| Total lifecycle Carbon footprint | 13 kg CO2 eq. |
| Carbon footprint of the manufacturing phase [A1 to A3] | 1 kg CO2 eq. |
| Carbon footprint of the distribution phase [A4] | 0 kg CO2 eq. |
| Carbon footprint of the installation phase [A5] | 0 kg CO2 eq. |
| Carbon footprint of the use phase [B2, B3, B4, B6] | 11 kg CO2 eq. |
| Carbon footprint of the end-of-life phase [C1 to C4] | 0.1 kg CO2 eq. |
| Environmental Disclosure | Product Environmental Profile |

Use Better



Materials and Substances

| | |
|--|-----|
| Packaging made with recycled cardboard | Yes |
| Packaging without single use plastic | Yes |

Use Longer



Lifetime extension

| | |
|--------|----|
| Repair | No |
|--------|----|

Use Again



Repack and remanufacture

| | |
|---------------------------------|---|
| Recyclability potential, in % | 87 |
| End of life manual availability | End of Life Information |
| Take-back | No |
| WEEE Label |  The product must be disposed on European Union markets following specific waste collection and never end up in rubbish bins |

Dimensions Drawings

Dimensions

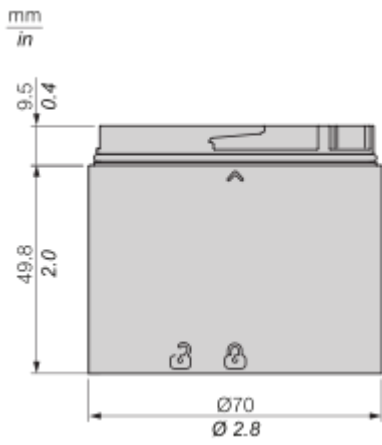

Mounting and Clearance

Mounting Overview



| Drawing | Part Number | Part Description |
|---------|-------------|------------------|
|---------|-------------|------------------|

| | | |
|--------------|-------------|------------------------------------|
| A1, A6, A11 | XVB7C21B... | 24V Base Direct / Tube & Cover |
| A1, A7, A11 | XVB7C31 | IO Link Base Direct / Tube & Cover |
| A1, A8, A11 | XVB7C51 | USB Base Direct / Tube & Cover |
| A1, A9, A11 | XVB7C61 | M12 Base Direct / Tube & Cover |
| A1, A10, A11 | XVB7C21M... | AC Base Direct / Tube & Cover |
| A2 | XVB7C9S... | 2 Tones Buzzer |
| A2 | XVB7C9T | 8 Tones Buzzer |
| A2 | XVB7C9SS | Self-Adjust Sounder 1 Tone |
| A3 | XVB7L2... | Beacon Steady Lens |
| | XVB7L6... | Beacon Flashing Lens |
| A4 | XVB7C9V | Editable Voice Alarm |
| A5 | XVB7C2... | Steady Lens |
| | XVB7C5... | Blinking Lens |
| | XVB7C6... | Flashing Lens |
| | XVB7CR... | Rotating Lens |
| | XVB7CM9 | Multi-function Clear lens |
| A12 | XVZ00 | 1/2" NPT Adapter |
| A13 | XVZ02... | Plastic Fixing Plate With Pole |
| A14 | XVZ100 | Alu Ø25mm Pole 100mm Length |
| A15 | XVZ250 | Alu Ø25mm Pole 250mm Length |
| A16 | XVZ400 | Alu Ø25mm Pole 400mm Length |
| A17 | XVZ800 | Alu Ø25mm Pole 800mm Length |
| A18 | XVZ100T | L Bracket Alu Ø25mm Pole 100mm |
| A19 | XVZ250T | L Bracket Alu Ø25mm Pole 250mm |
| A20 | XVZ01... | Plastic Fixing Plate |
| A21 | XVZ11 | Metal Fixing Plate |
| A22 | XVZ06... | Plastic Foldable Bracket |
| A23 | XVZ09 | Plastic Wall Mount Bracket |

| | | |
|-----|-------|--------------------|
| A24 | XVZ07 | Side Entry Adapter |
| A25 | XVZ08 | Magnetic Adapter |

Technical Illustration

Dimensions



Offer Marketing Illustration

Product benefits / Features

Features

Harmony XVB7



Sustainability: high brightness with low power consumption realized via energy efficient LED



Elevated design with a modern twist to enhance machine aesthetic



Modular design for adaptability, ease of maintenance and low inventory



Wide base variety with the option to be connected via USB & IO-link base



Adjustable and customizable sounder with maximum sound pressure of up to 102dB

Offer Marketing Illustration

Product benefits / Features

Technical Benefits

Harmony XVB7

Conformity with IEC, CUL and CCC standards, as well as CE marking

Up to IP66 and type 4X protection ratings

High shock and vibration resistance up to 6g



Energy efficient LED with operating life up to 50,000 hours

Save up to 75% wiring time with M12 connection and push-in terminal

High brightness level with illuminance up to 3000cd/m²

Image of product / Alternate images

Alternative

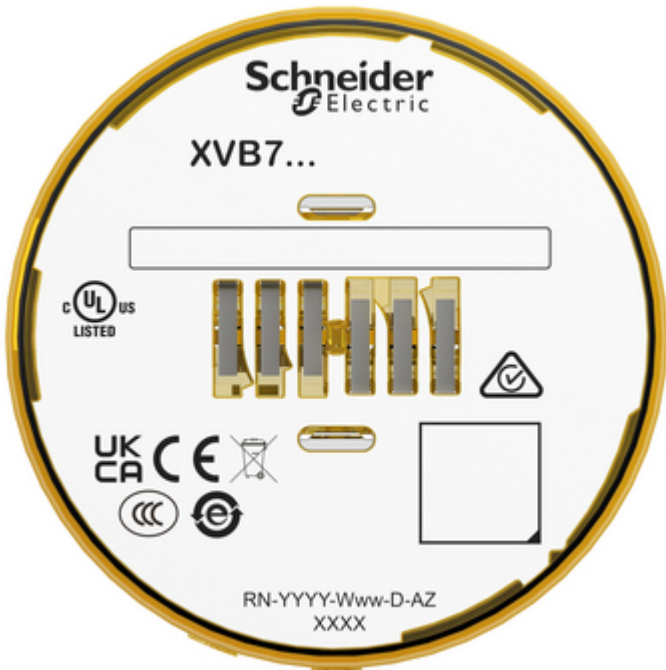
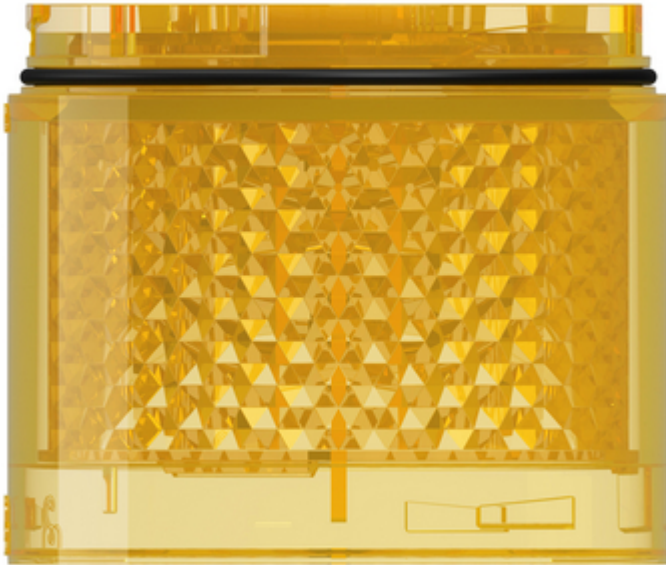

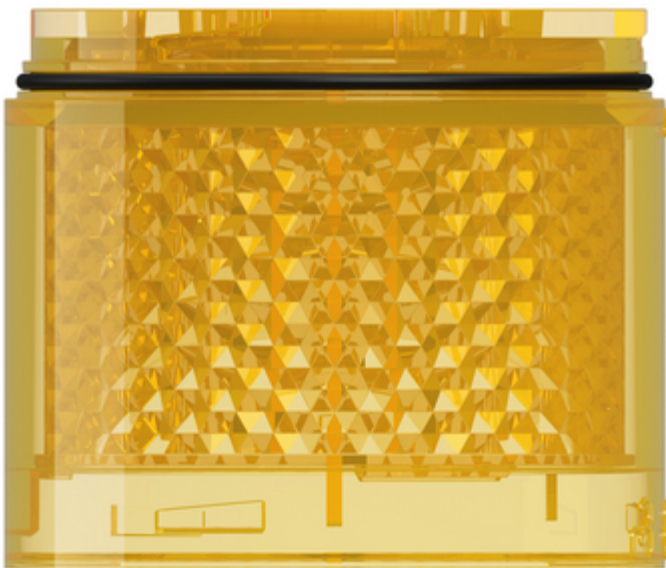
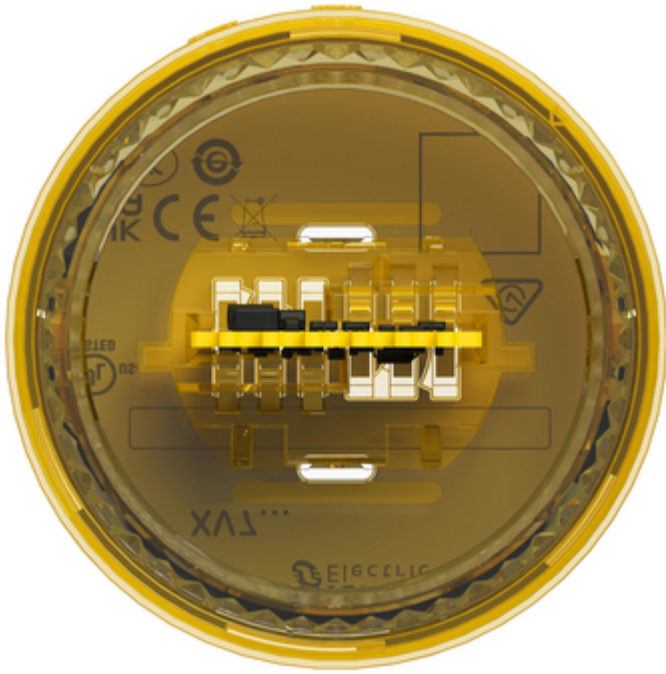

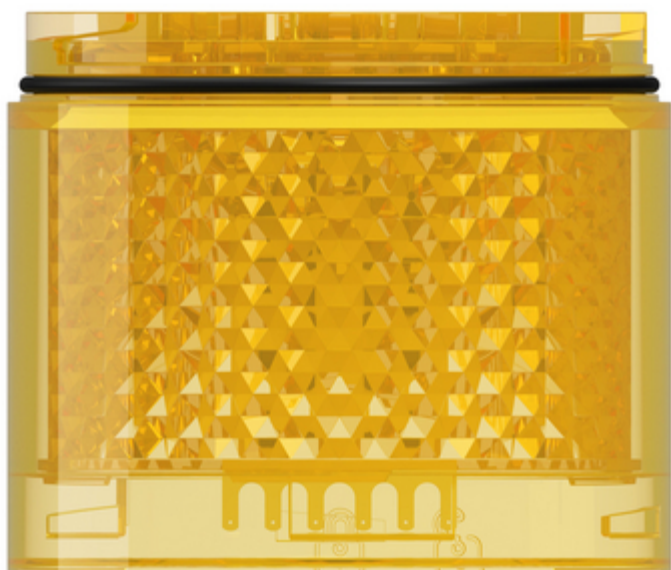
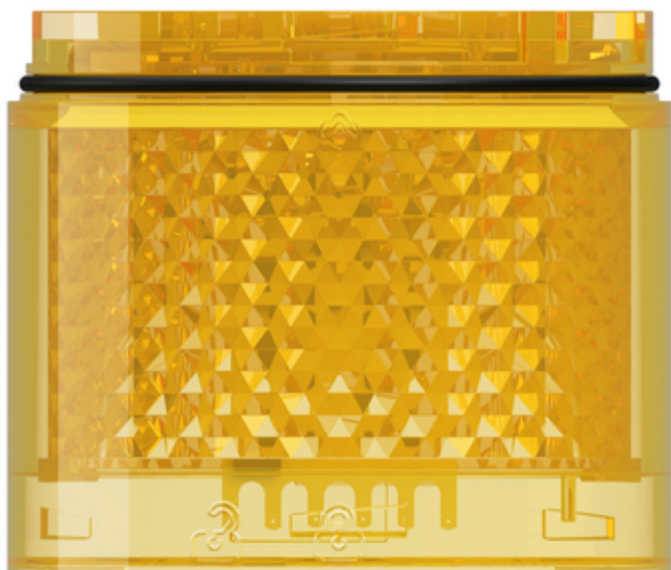

Image of product in real life situation

