



switch disconnector with fuse 32 A, frame size 1, 4-pole for LV HRC fuse size 000 and 00 front operating mechanism left basic unit without handle box terminal without fuses

Model	
product brand name	SENTRON
product designation	3KF switch disconnector with fuses
design of the product	3KF switch disconnector with fuses
product version	3KF NH
design of the actuating element	without
design of handle	Without
direction of actuation	from the front
type of the driving mechanism motor drive	No
number of poles	4
size of disconnecting link	00 and 000
size of switch disconnector	1
size of fuse link	NH000, NH00
mechanical service life (operating cycles) typical	15 000
electrical endurance (operating cycles)	
• at AC-23 A at 440 V	10 000
• at AC-23 A at 690 V	6 000
• at DC-23 A at 440 V	1 500
I <sup>2</sup> t value	
• with closed switch for combination switch + fuse at 500 V maximum	33 200 A <sup>2</sup> ·s
• with closed switch for combination switch + fuse at 400 V maximum	33 200 A <sup>2</sup> ·s
• with closed switch at 690 V for combination switch + gG fuse maximum	40 700 A <sup>2</sup> ·s
• of the fuse at 500 V maximum permissible	34 000 A <sup>2</sup> ·s
• of the gG fuse at 690 V maximum permissible	55 000 A <sup>2</sup> ·s
• of the aM fuse at 690 V maximum permissible	55 000 A <sup>2</sup> ·s
position of the switch operating mechanism	left
fuse system	LV HRC fuse
overvoltage category	IV
operating voltage with current paths in series	
• with degree of pollution 2 at DC rated value	440 / 3
• with degree of pollution 3 at DC rated value	440 / 3
surge voltage resistance rated value	12 kV
Supply voltage	
operating voltage at AC rated value maximum	690 V
Protection class	
protection class IP	IP20
protection class IP	





<ul style="list-style-type: none"> <li>with closed switch with cover or cable lug cover</li> </ul>	IP20
<ul style="list-style-type: none"> <li>on the front</li> </ul>	IP20
<b>Dissipation</b>	
<b>power loss [W]</b>	
<ul style="list-style-type: none"> <li>with conventional rated thermal current per pole</li> </ul>	0.4 W
<ul style="list-style-type: none"> <li>with conventional rated thermal current per device</li> </ul>	1.2 W
<ul style="list-style-type: none"> <li>with conventional rated thermal current without fuse per pole</li> </ul>	0.4 W
<ul style="list-style-type: none"> <li>with conventional rated thermal current without fuse per device</li> </ul>	1.2 W
<ul style="list-style-type: none"> <li>for rated value of the current at AC in hot operating state per pole</li> </ul>	0.4 W
<ul style="list-style-type: none"> <li>of the fuse per fuse maximum</li> </ul>	6.5 W
<b>Main circuit</b>	
operating power at AC-23 A at 500 V rated value	18.5 kW
operational current rated value	32 A
<b>Auxiliary circuit</b>	
<b>number of connected NC contacts for auxiliary contacts</b>	0
<b>number of connected NO contacts for auxiliary contacts</b>	0
<b>number of connected CO contacts for auxiliary contacts</b>	0
number of CO contacts for auxiliary contacts	4
<b>number of NC contacts for auxiliary contacts</b>	0
<b>number of NO contacts for auxiliary contacts</b>	0
<b>suitability for use main switch</b>	Yes
<b>suitability for use switch disconnecter</b>	Yes
<b>suitability for use EMERGENCY OFF switch</b>	Yes
<b>suitability for use safety switch</b>	Yes
<b>suitability for use maintenance/repair switch</b>	Yes
<b>product feature interlock</b>	No
<b>product function phase failure monitoring</b>	No
<b>product component</b>	
<ul style="list-style-type: none"> <li>voltage trigger</li> </ul>	No
<ul style="list-style-type: none"> <li>undervoltage release</li> </ul>	No
<ul style="list-style-type: none"> <li>undervoltage release with leading contact</li> </ul>	No
<b>product feature sealable</b>	Yes
<b>product extension auxiliary switch</b>	Yes
<b>product extension optional locking capability</b>	Yes
<b>product extension optional motor drive</b>	No
<b>product extension optional fuse monitoring</b>	Yes
<b>product function</b>	
<ul style="list-style-type: none"> <li>fuse monitoring</li> </ul>	No
<ul style="list-style-type: none"> <li>overvoltage protection monitoring</li> </ul>	No
<b>Short circuit</b>	
short-circuit current making capacity (I <sub>cm</sub> ) for switch disconnecter at 690 V AC/440 V DC without fuse link rated value minimum	3.55 kA
<b>conditional short-circuit current with line-side fuse protection</b>	
<ul style="list-style-type: none"> <li>at 500 V by gG fuse rated value</li> </ul>	100 kA
<ul style="list-style-type: none"> <li>at 690 V by gG fuse rated value</li> </ul>	100 kA
<b>Connections</b>	
arrangement of electrical connectors for main current circuit	Top and bottom
<b>tightening torque with screw-type terminals</b>	
<ul style="list-style-type: none"> <li>minimum</li> </ul>	5 N·m
<ul style="list-style-type: none"> <li>maximum</li> </ul>	6.5 N·m
type of connectable conductor cross-sections with flexible busbar	2x (0.8 x 9 mm <sup>2</sup> )
<b>type of connectable conductor cross-sections for copper conductor</b>	
<ul style="list-style-type: none"> <li>solid</li> </ul>	1x (1 ... 16 mm <sup>2</sup> )
<ul style="list-style-type: none"> <li>finely stranded with core end processing</li> </ul>	1x (6 ... 25 mm <sup>2</sup> )

• stranded	1x (6 ... 25 mm <sup>2</sup> )
type of electrical connection for main current circuit	box terminal
<b>Mechanical Design</b>	
height	122 mm
width	185.5 mm
depth	130.5 mm
fastening method	Floor mounting and snap-on mounting on 35 mm standard mounting rail
fastening method	
• 4-hole front mounting	No
• front mounting with central attachment	No
• rail mounting	Yes
mounting position	any
Net Weight	1.873 kg

<b>Environmental conditions</b>	
ambient temperature during operation	
• minimum	-25 °C
• maximum	70 °C
ambient temperature during storage	
• minimum	-50 °C
• maximum	80 °C

**Approvals Certificates**

Environment	General Product Approval				
<a href="#">Environmental Confirmations</a>	<a href="#">Environmental Confirmations</a>			<a href="#">Confirmation</a>	

General Product Approval	Test Certificates	Maritime application	other
	<a href="#">Miscellaneous</a>		<a href="#">Type Test Certificates/Test Report</a>
			

other	
<a href="#">Miscellaneous</a>	<a href="#">Confirmation</a>

**Further information**

- Information on the packaging  
<https://support.industry.siemens.com/cs/ww/en/view/109813875>
- Information for data generation and storage  
<https://support.industry.siemens.com/cs/ww/en/view/109995012>
- Information- and Downloadcenter (Catalogs, Brochures,...)  
<https://www.siemens.com/lowvoltage/catalogs>
- Industry Mall (Online ordering system)  
<https://mall.industry.siemens.com/mall/en/en/Catalog/product?mlfb=3KF1403-0LB11>
- Service&Support (Manuals, Certificates, Characteristics, FAQs,...)  
<https://support.industry.siemens.com/cs/ww/en/ps/3KF1403-0LB11>
- Image database (product images, 2D dimension drawings, 3D models, device circuit diagrams, ...)  
[https://www.automation.siemens.com/bilddb/cax\\_en.aspx?mlfb=3KF1403-0LB11](https://www.automation.siemens.com/bilddb/cax_en.aspx?mlfb=3KF1403-0LB11)
- CAX-Online-Generator  
<https://www.siemens.com/cax>
- Tender specifications  
<https://www.siemens.com/specifications>
- Characteristic curves  
[https://curves.simaris.siemens.com/curves/<mmp\\_prod\\_noCOMP="HAUPT"></mmp\\_prod\\_no>](https://curves.simaris.siemens.com/curves/<mmp_prod_noCOMP=)

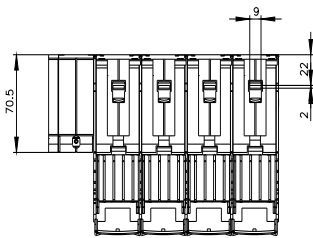
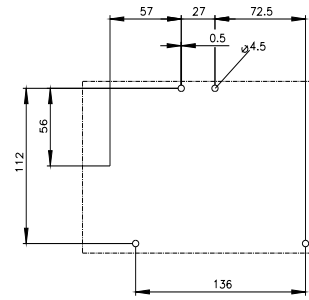
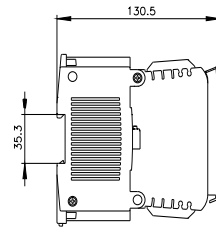
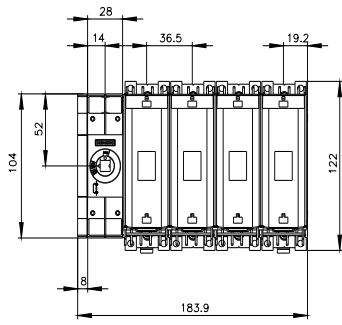



last modified:

4/3/2025 