

# Product datasheet

Specifications



## single light block for test light function 12V

Local distributor code:

393612781

ZBZG156

EAN Code: 3389118030107

## Main

Range of product	Harmony XB4 Harmony XB5
Product or component type	Block for test light
Product compatibility	Integral LED BA 9s
Light block type	Single block for test light function
[Us] rated supply voltage	12 V AC/DC 24 V AC/DC 24...120 V AC/DC
Electrical connection	1 wire

## Complementary

Material	Plastic
Electrical shock protection class	Class I for Harmony XB4 conforming to IEC 60536 Class II for Harmony XB5 conforming to IEC 60536
Product weight	0.01 kg

## Environment

Ambient air temperature for storage	-40...70 °C
Ambient air temperature for operation	-25...70 °C
Standards	UL 508 IEC 60947-5-5 IEC 60947-1 IEC 60947-5-4 IEC 60947-5-1 IEC 60947-5-5 IEC 60947-5-4 CSA C22.2 No 14 IEC 60947-1 IEC 60947-5-1 JIS C 4520
Product certifications	DNV UL listed LROS (Lloyds register of shipping) BV CSA
Vibration resistance	5 gn (f= 2...500 Hz) conforming to IEC 60068-2-6
Shock resistance	30 gn for 18 ms conforming to IEC 60068-2-27 50 gn for 11 ms conforming to IEC 60068-2-27

## Packing Units

Unit Type of Package 1	PCE
------------------------	-----

<b>Number of Units in Package 1</b>	1
<b>Package 1 Height</b>	3.4 cm
<b>Package 1 Width</b>	8.8 cm
<b>Package 1 Length</b>	5.2 cm
<b>Package 1 Weight</b>	18.0 g
<b>Unit Type of Package 2</b>	S03
<b>Number of Units in Package 2</b>	165
<b>Package 2 Height</b>	30.0 cm
<b>Package 2 Width</b>	30.0 cm
<b>Package 2 Length</b>	40.0 cm
<b>Package 2 Weight</b>	3.65 kg

## Logistical informations

<b>Country of origin</b>	FR
--------------------------	----

## Contractual warranty

<b>Warranty (in months)</b>	18
-----------------------------	----



## Environmental Data

Schneider Electric aims to achieve Net Zero status by 2050 through supply chain partnerships, lower impact materials, and circularity via our ongoing “Use Better, Use Longer, Use Again” campaign to extend product lifetimes and recyclability.

[Environmental Data explained >](#)

[How we assess product sustainability >](#)



### Environmental footprint

Total lifecycle Carbon footprint	0.1 kg CO2 eq.
Carbon footprint of the manufacturing phase [A1 to A3]	0.1 kg CO2 eq.
Carbon footprint of the distribution phase [A4]	0 kg CO2 eq.
Carbon footprint of the installation phase [A5]	0 kg CO2 eq.
Carbon footprint of the use phase [B2, B3, B4, B6]	0 kg CO2 eq.
Carbon footprint of the end-of-life phase [C1 to C4]	0 kg CO2 eq.
Environmental Disclosure	<a href="#">Product Environmental Profile</a>

### Use Better



### Materials and Substances

Packaging made with recycled cardboard	Yes
Packaging without single use plastic	Yes
EU RoHS Directive	<a href="#">Compliant</a>
REACH Regulation	<a href="#">Free of Substances of Very High Concern above the threshold</a>

### Use Longer



### Lifetime extension

Repair	No
--------	----

### Use Again



### Repack and remanufacture

Recyclability potential, in %	15
End of life manual availability	<a href="#">End of Life Information</a>
Take-back	Nej
WEEE Label	 The product must be disposed on European Union markets following specific waste collection and never end up in rubbish bins

Connections and Schema

Wiring Diagram

---

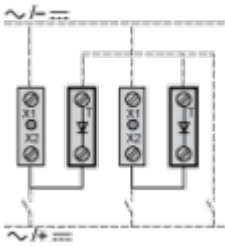

Technical Illustration

Wiring diagram

---

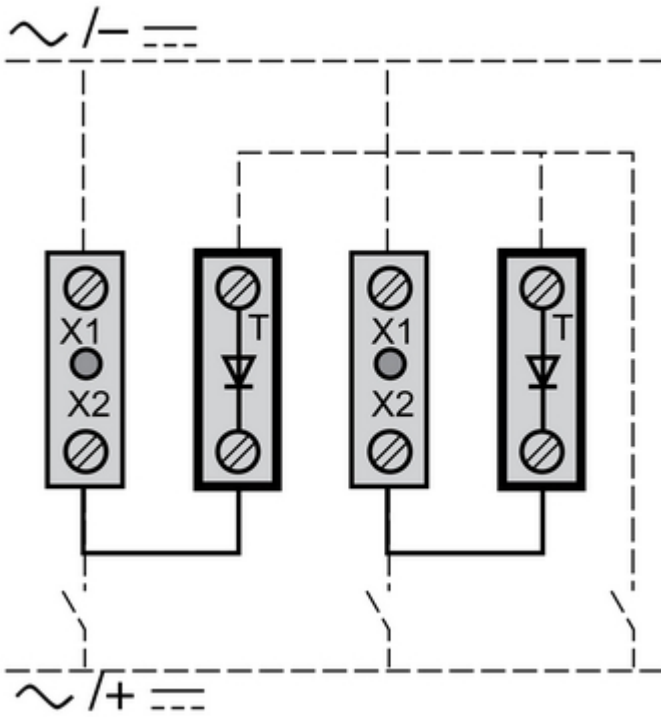

Offer Marketing Illustration



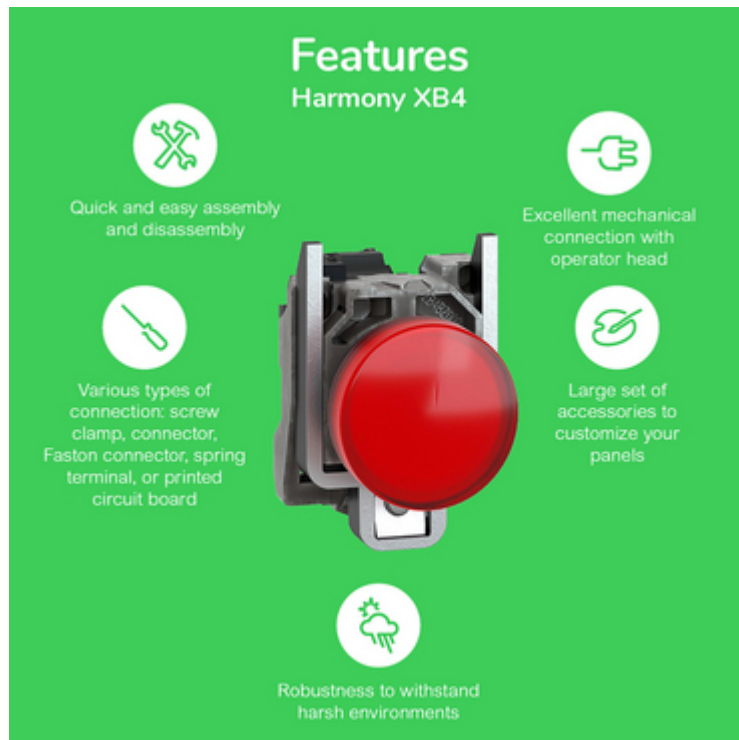

Product benefits / Features

---



The infographic features a central image of a red Schneider XB4 terminal block. It is surrounded by five circular icons, each with a corresponding text description of a feature. The background is a solid green color.

### Features Harmony XB4

-  Quick and easy assembly and disassembly
-  Various types of connection: screw clamp, connector, Faston connector, spring terminal, or printed circuit board
-  Excellent mechanical connection with operator head
-  Large set of accessories to customize your panels
-  Robustness to withstand harsh environments

Offer Marketing Illustration

Product benefits / Features

---

## Technical Benefits

### Harmony XB4

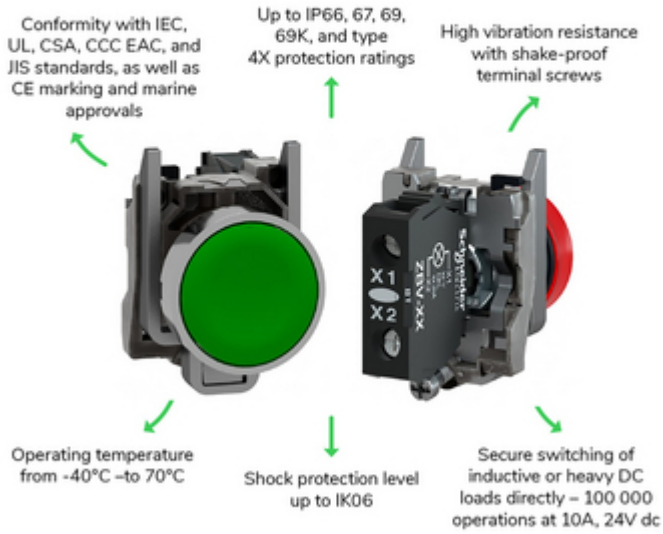

Image of product / Alternate images

Alternative

---





