

Product datasheet

Specifications



miniature plug-in relay - Harmony RXM2L - 2 C/O - 230 V AC - 5 A - with LED

Local distributor code:
403012666

RXM2LB2P7

EAN Code: 3389119215336

Main

Range of product	Harmony Electromechanical Relays
Series name	RXM series
Product or component type	Plug-in relay
Relay type	Miniature relay
Contacts type and composition	2 C/O
[Uc] control circuit voltage	230 V AC 50/60 Hz
[Ithe] conventional enclosed thermal current	5 A at -40...55 °C

Complementary

status LED	With
Control type	Without lockable test button
[Ie] rated operational current	2.5 A at 28 V (DC) NC conforming to IEC 2.5 A at 250 V (AC) NC conforming to IEC 5 A at 28 V (DC) NO conforming to IEC 5 A at 250 V (AC) NO conforming to IEC 5 A at 24 V (DC) NO conforming to IEC 5 A at 220 V (AC) NO conforming to IEC 5 A at 28 V (DC) conforming to UL 5 A at 250 V (AC) conforming to UL
Minimum switching capacity	25 mW subject to switching frequency, environment or expected reliability level etc
Rated operational voltage limits	184...253 V AC
[Ui] rated insulation voltage	250 V conforming to IEC
Maximum switching voltage	250 V AC 28 V DC
Drop-out voltage threshold	$\geq 0.15 U_c$ AC
Load current	5 A at 250 V AC 5 A at 28 V DC
Maximum switching capacity	1250 VA AC 140 W DC
Minimum switching current	5 mA subject to switching frequency, environment or expected reliability level etc
Minimum switching voltage	5 V subject to switching frequency, environment or expected reliability level etc
Average resistance	16500 Ohm at 23 °C +/- 15 %
Mechanical durability	20000000 cycles
Electrical durability	200000 cycles resistive load 23 °C 100000 cycles resistive load at 55 °C
Safety reliability data	B10d = 100000

Operating rate	<= 1200 cycles/hour under load <= 18000 cycles/hour no-load
Utilisation coefficient	20 %
Dielectric strength	2000 V AC between coil and contact with basic insulation 2000 V AC between poles with basic insulation 1000 V AC between contacts with micro disconnection
Protection category	RT I
Pollution degree	3
Operating position	Any position
Test levels	Level A group mounting
Sale per indivisible quantity	10
Contacts material	Silver alloy (Ag/Ni)
Shape of pin	Flat (faston type)
Product weight	0.031 kg

Environment

Standards	CE IEC 61810-1 (iss. 2) UL 508
Ambient air temperature for storage	-40...85 °C
Vibration resistance	3 gn, amplitude = +/- 1 mm (f = 10...50 Hz)operating conforming to IEC 60068-2-6 6 gn, amplitude = +/- 1 mm (f = 10...50 Hz)not operating conforming to IEC 60068-2-6
Shock resistance	30 gn for not operating conforming to IEC 60068-2-27 10 gn for in operation conforming to IEC 60068-2-27

Packing Units

Unit Type of Package 1	PCE
Number of Units in Package 1	1
Package 1 Height	2.000 cm
Package 1 Width	3.000 cm
Package 1 Length	4.500 cm
Package 1 Weight	32.000 g
Unit Type of Package 2	BB1
Number of Units in Package 2	10
Package 2 Height	3.000 cm
Package 2 Width	10.500 cm
Package 2 Length	12.000 cm
Package 2 Weight	348.000 g
Unit Type of Package 3	S02
Number of Units in Package 3	240
Package 3 Height	15.000 cm
Package 3 Width	30.000 cm
Package 3 Length	40.000 cm
Package 3 Weight	8.612 kg

Logistical informations

Country of origin CN

Contractual warranty

Warranty (in months) 18



Environmental Data

Schneider Electric aims to achieve Net Zero status by 2050 through supply chain partnerships, lower impact materials, and circularity via our ongoing “Use Better, Use Longer, Use Again” campaign to extend product lifetimes and recyclability.

[Environmental Data explained >](#)

[How we assess product sustainability >](#)



Environmental footprint

Total lifecycle Carbon footprint	20 kg CO2 eq.
Carbon footprint of the manufacturing phase [A1 to A3]	0.3 kg CO2 eq.
Carbon footprint of the distribution phase [A4]	0 kg CO2 eq.
Carbon footprint of the installation phase [A5]	0 kg CO2 eq.
Carbon footprint of the use phase [B2, B3, B4, B6]	19 kg CO2 eq.
Carbon footprint of the end-of-life phase [C1 to C4]	0 kg CO2 eq.
Environmental Disclosure	Product Environmental Profile

Use Better



Materials and Substances

Packaging made with recycled cardboard	Yes
Packaging without single use plastic	Yes
EU RoHS Directive	Compliant
REACH Regulation	Free of Substances of Very High Concern above the threshold

Use Longer



Lifetime extension

Repair	No
--------	----

Use Again



Repack and remanufacture

End of life manual availability	End of Life Information
Take-back	No
WEEE Label	 The product must be disposed on European Union markets following specific waste collection and never end up in rubbish bins

Dimensions Drawings

Dimensions

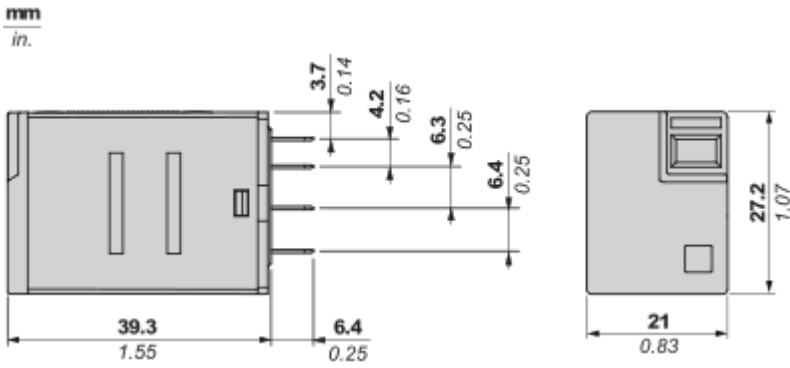

Pin Side View

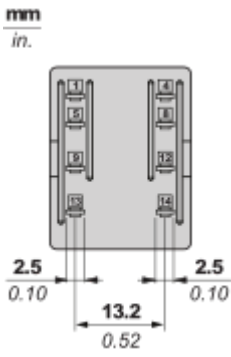

Connections and Schema

Wiring Diagram

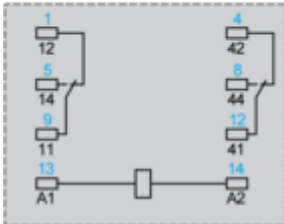

Symbols shown in blue correspond to Nema marking.

Performance Curves

Electrical Durability of Contacts

Durability (inductive load) = durability (resistive load) x reduction coefficient.

For 2 Poles Relay

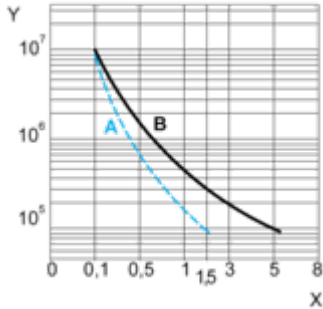

X : Contact current (A)

Y : Durability (Number of operating cycles)

A : Inductive load

B : Resistive load

Note : These are typical curves, actual durability depends on load, environment, duty cycle, etc.

For inductive load, to increase relay life cycles, please add a proper load protection circuit (eg: RC protection/Varistor/free Wheeling diode -DC load only-)

Maximum Switching Capacity

For 2 Poles Relay

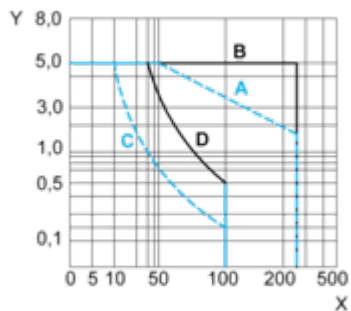

X : Contact voltage (v)

Y : Contact current (A)

A : Inductive AC load

B : Resistive AC load

C : Inductive DC load

D : Resistive DC load

Note : These are typical curves, actual durability depends on load, environment, duty cycle, etc.

For inductive load, to increase relay life cycles, please add a proper load protection circuit (eg: RC protection/Varistor/free Wheeling diode -DC load only-)

For low level loads (below 10mA), we recommend to use RXM*GB series with bifurcated contacts relays instead.

AC Coil Voltage and Operating Temperature under continuous duty

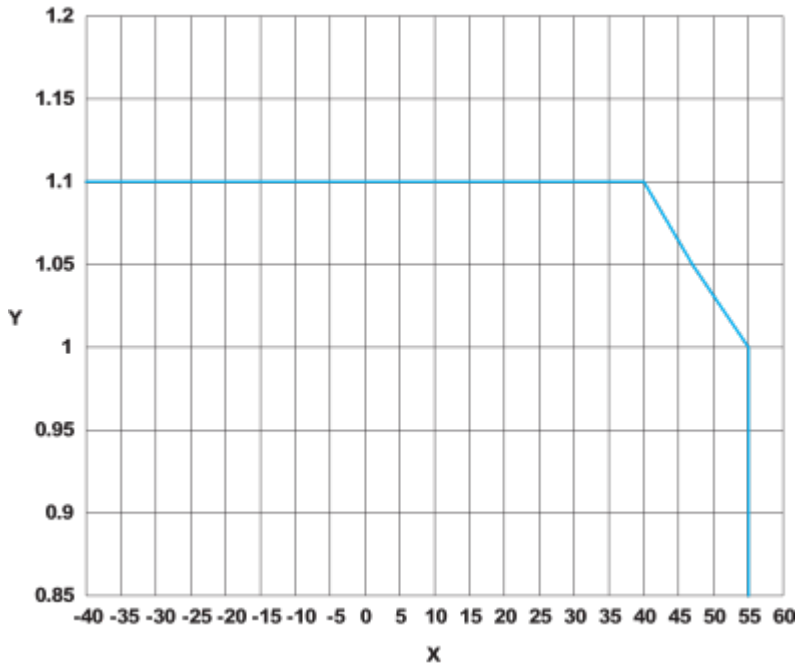

X : Operating temperature (°C)

Y : AC coil voltage (UC)

Technical Illustration

Dimensions

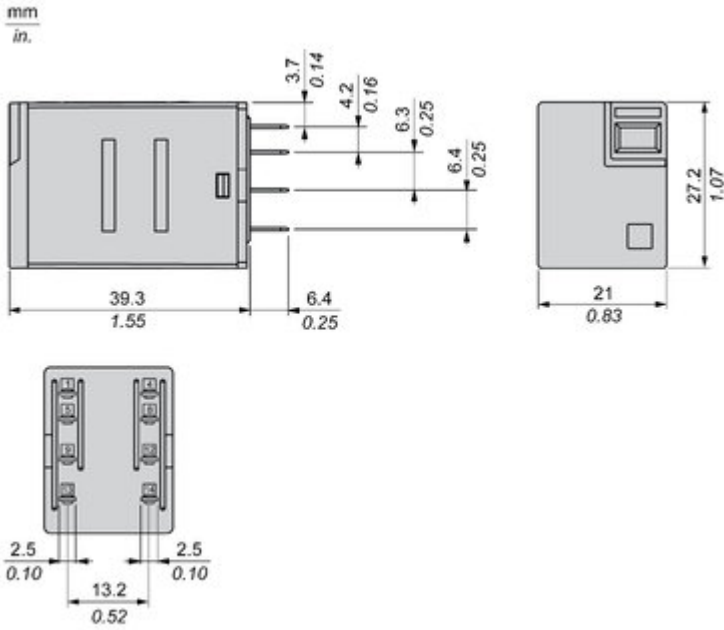

Offer Marketing Illustration

Product benefits / Features

Technical Benefits

Easy Harmony RXMLB Relay

RXM*LB sockets:

- Mixed contact arrangement
- Screw clamp terminal

Metal maintaining clamp:
reliable in vibration
environment

Finger grip cover to
easily remove relay
from socket



RXM*LB sockets:

- 2CO-5A, 4CO-3A
- 12-110VDC, 24-230VAC

Mechanical indicator
for contact status

"Power On" LED for
relays status

Offer Marketing Illustration

Product benefits / Features

Features

Easy Harmony RXMLB Relay



Fit to customer needs
coverage of most general
control panel applications



Easy to select
simple selection and
wide availability





Convenient to use
Easy status readiness
through mechanical
indicator & LED



Safe to perform
product reliability,
compliance with
industrial standard
and eco-design

Image of product / Alternate images

Alternative



