

SICK

BTFO8-A1ZM02S01

HighLine

WIRE DRAW ENCODERS

SICK
Sensor Intelligence.



Ordering information

Type	part no.
BTF08-A1ZM02S01	1133019

Included in delivery: MRA-F080-102D2 (1), AHM36A-S3PZ000S21 (1)

Other models and accessories → www.sick.com/HighLine



Detailed technical data

Features

Special device	✓
Specialty	BTF08-A1AM0240 successor: Encoder AHM36A-S3PZ000S21, 1132998 pre-assembled
Standard reference device	BTF08-A1AM0240, 1034299

Safety-related parameters

MTTF_D (mean time to dangerous failure)	230 years (EN ISO 13849-1) ¹⁾
--	--

¹⁾ This product is a standard product and does not constitute a safety component as defined in the Machinery Directive. Calculation based on nominal load of components, average ambient temperature 40°C, frequency of use 8760 h/a. All electronic failures are considered hazardous. For more information, see document no. 8015532.

Performance

Measurement range	0 m ... 2 m
Encoder	Absolute encoders
Resolution (wire draw + encoder)	0.03 mm ^{1) 2)}
Repeatability	≤ 1 mm ³⁾
Linearity	≤ ± 2 mm ³⁾
Hysteresis	≤ 2 mm ³⁾

¹⁾ The values shown have been rounded.

²⁾ Example calculation based on the BTF08 with PROFINET: 200 mm (wire draw length per revolution - see Mechanical data): 262,144 (number of steps per revolution) = 0.001 mm (resolution of wire draw + encoder combination).

³⁾ Value applies to wire draw mechanism.

Interfaces

Communication interface	SSI
Programmable/configurable	✓

Electronics

Connection type	Special version
Connection type Detail	Cable, 8-wire, with male connector, M23, 12-pin, universal, 0.1 m
Supply voltage	4.5 V DC ... 32 V

Power consumption	≤ 1.5 W (without load)
--------------------------	------------------------

Mechanics

Weight	1.62 kg
Measuring wire material	Highly flexible stranded steel 1,4401 stainless steel V4A
Measuring wire diameter	1.35 mm
Weight (measuring wire)	7.1 g/m
Housing material, wire draw mechanism	Aluminum (anodized), aluminum die cast (nickel-plated)
Spring return force	6 N ... 14 N ¹⁾
Length of wire pulled out per revolution	200 mm
Life of wire draw mechanism	Typ. 1,000,000 cycles ^{2) 3)}
Actual wire draw length	2.2 m
Wire acceleration	40 m/s ²
Operating speed	8 m/s
Mounted encoder	AHM36 SSI, AHM36A-S3PZ000S21, 1132998
Mounted mechanic	MRA-F080-102D2, 6028625

¹⁾ These values were measured at an ambient temperature of 25 °C. There may be variations at other temperatures.

²⁾ Average values, which depend on the application.

³⁾ The service life depends on the type of load. This is influenced by environmental conditions, the installation location, the measuring range in use, the traversing speed, and acceleration.

Ambient data

EMC	According to EN 61000-6-2 and EN 61000-6-3
Enclosure rating	IP64, mounted mechanic IP66, Encoder (IEC 60529) IP67, Encoder (IEC 60529)
Operating temperature range	-30 °C ... +70 °C

Classifications

ECLASS 5.0	27270590
ECLASS 5.1.4	27270590
ECLASS 6.0	27270590
ECLASS 6.2	27270590
ECLASS 7.0	27270590
ECLASS 8.0	27270590
ECLASS 8.1	27270590
ECLASS 9.0	27270590
ECLASS 10.0	27270613
ECLASS 11.0	27270503
ECLASS 12.0	27270503
ETIM 5.0	EC001486
ETIM 6.0	EC001486
ETIM 7.0	EC001486
ETIM 8.0	EC001486
UNSPSC 16.0901	41112113

Certificates

EU declaration of conformity	✓
UK declaration of conformity	✓
ACMA declaration of conformity	✓
Moroccan declaration of conformity	✓
China RoHS	✓

Dimensional drawing

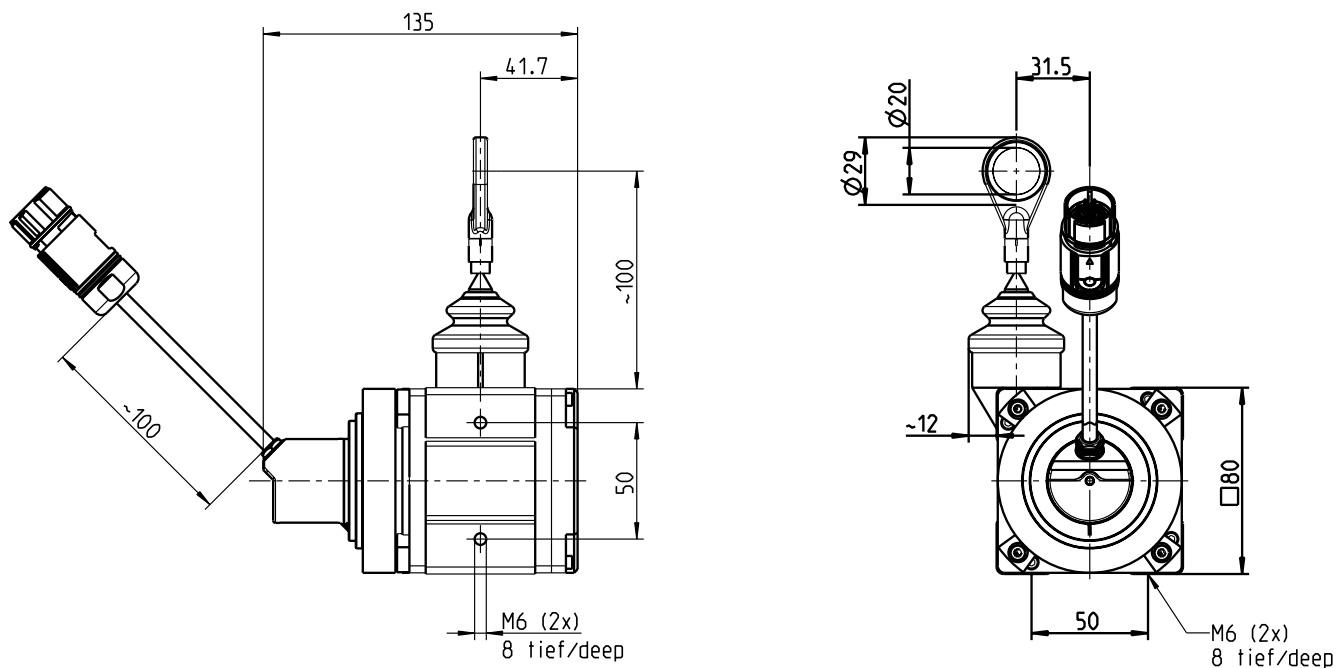

Dimensions in mm (inch)



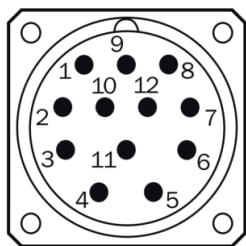

Anschlussbelegung





PIN	Signal	Explanation
1	GND	Ground connection
2	Data+	Interface signal
3	Clock+	Interface signal
4	n/c	Not connected
5	n/c	Not connected
6	n/c	Not connected
7	n/c	Not connected
8	Us	Operating voltage
9	SET	Electronic adjustment
10	Data-	Interface signal
11	Clock-	Interface signal
12	V/R	Sequence in direction of rotation
-	Screen	Housing potential

Recommended accessories

Other models and accessories → www.sick.com/HighLine

	Brief description	Type	part no.
Mounting systems			
	<ul style="list-style-type: none"> Description: Flange adapter for HighLine wire draw mechanisms, adaption of face mount flange with centering hub 20 mm to 50 mm servo flange Material: Aluminum Details: Aluminum Items supplied: Including 3 countersunk screws M3 x 10 	BEF-FA-020-050WDE	2073776
	<ul style="list-style-type: none"> Description: Joint ball for later insertion in wire end ring with 20 mm diameter. The use of this joint ball enables movement in multiple levels of freedom. 	Joint protection for wire rope BTF/PRF/MRA	5318683
	<ul style="list-style-type: none"> Description: Compressed air attachment for MRA-F080... and MRA-F130... HighLine wire draw mechanism 	MRA-F-P	6073769
	<ul style="list-style-type: none"> Description: Additional brush attachment for wire draw mechanism MRA-F080 (2 m and 3 m from HighLine series) 	MRA-F080-B	6045341
	<ul style="list-style-type: none"> Description: Wire draw deflection pulley for wire draw mechanism MRA-F080 (2m and 3m from HighLine series) 	MRA-F080-R	6028632

	Brief description	Type	part no.
connectors and cables			
	<ul style="list-style-type: none"> Description: SSI, shielded, RS-422, TTL, HTL Connection type head A: Female connector, M23, 12-pin, straight Connection type head B: Flying leads Signal type: SSI, RS-422, TTL, HTL Cable: 3 m, 12-wire, PUR, halogen-free Application: Zones with oils and lubricants 	DOL-2312-G03MMA1	2029201
	<ul style="list-style-type: none"> Description: SSI, shielded, RS-422, TTL, HTL Connection type head A: Female connector, M23, 12-pin, straight Connection type head B: Flying leads Signal type: SSI, RS-422, TTL, HTL Cable: 5 m, 12-wire, PUR, halogen-free Application: Zones with oils and lubricants 	DOL-2312-G05MMA1	2029202
	<ul style="list-style-type: none"> Description: SSI, shielded, RS-422, TTL, HTL Connection type head A: Female connector, M23, 12-pin, straight Connection type head B: Flying leads Signal type: SSI, RS-422, TTL, HTL Cable: 1.5 m, 12-wire, PUR, halogen-free Application: Zones with oils and lubricants 	DOL-2312-G1M5MA1	2029200
	<ul style="list-style-type: none"> Description: SSI, shielded, RS-422, TTL, HTL Connection type head A: Female connector, M23, 12-pin, straight Connection type head B: Flying leads Signal type: SSI, RS-422, TTL, HTL Cable: 10 m, 12-wire, PUR, halogen-free Application: Zones with oils and lubricants 	DOL-2312-G10MMA1	2029203
	<ul style="list-style-type: none"> Description: SSI, shielded, RS-422 Connection type head A: Female connector, M23, 12-pin, straight Connection type head B: Flying leads Signal type: SSI, RS-422 Cable: 20 m, 12-wire, PUR, halogen-free Application: Zones with oils and lubricants 	DOL-2312-G20MMA1	2029204
	<ul style="list-style-type: none"> Description: SSI, shielded, RS-422 Connection type head A: Female connector, M23, 12-pin, straight Connection type head B: Flying leads Signal type: SSI, RS-422 Cable: 30 m, 12-wire, PUR, halogen-free Application: Zones with oils and lubricants 	DOL-2312-G30MMA1	2029205
	<ul style="list-style-type: none"> Description: HIPEFACE[®], shielded, SSI, Incremental Connection type head A: Female connector, M23, 9-pin, straight, A-coded Signal type: HIPEFACE[®], SSI, Incremental Connection systems: Solder connection 	DOS-2309-G	6028533
	<ul style="list-style-type: none"> Description: HIPEFACE[®], shielded, SSI, Incremental Connection type head A: Female connector, M23, 12-pin, straight, A-coded Signal type: HIPEFACE[®], SSI, Incremental Connection systems: Solder connection 	DOS-2312-G	6027538
	<ul style="list-style-type: none"> Description: HIPEFACE[®], shielded, SSI, Incremental Connection type head A: Female connector, M23, 12-pin, angled, A-coded Signal type: HIPEFACE[®], SSI, Incremental Connection systems: Solder connection 	DOS-2312-W01	2072580
	<ul style="list-style-type: none"> Description: HIPEFACE[®], shielded, SSI, Incremental, RS-422 Connection type head A: Male connector, M23, 12-pin, straight, A-coded Signal type: HIPEFACE[®], SSI, Incremental, RS-422 Connection systems: Solder connection 	STE-2312-G	6027537
	<ul style="list-style-type: none"> Description: SSI, shielded, RS-422, TTL, HTL Connection type head A: Female connector, M23, 12-pin, straight Connection type head B: Flying leads Signal type: SSI, RS-422, TTL, HTL Cable: 5 m, 12-wire, PUR, halogen-free 	DOL-2312-G05MMA1	2059786

	Brief description	Type	part no.
Wire draw mechanism			
	<ul style="list-style-type: none"> • Product segment: Wire draw mechanism • Product family: Wire draw mechanism for wire draw encoders • Description: HighLine wire draw mechanism for servo flange with 6 mm shaft, measuring range 0 m ... 2 m • Items supplied: Without encoder 	MRA-F080-102D2	6028625
programming devices			
	<ul style="list-style-type: none"> • Product segment: Programming devices • Product: PGT-01-S • Description: Programming tool for ATM60, ATM90, and KH53 • Items supplied: Power supply, interface, link cable, encoder cable, and software 	PGT-01-S	1030111

SICK AT A GLANCE

SICK is one of the leading manufacturers of intelligent sensors and sensor solutions for industrial applications. A unique range of products and services creates the perfect basis for controlling processes securely and efficiently, protecting individuals from accidents and preventing damage to the environment.

We have extensive experience in a wide range of industries and understand their processes and requirements. With intelligent sensors, we can deliver exactly what our customers need. In application centers in Europe, Asia and North America, system solutions are tested and optimized in accordance with customer specifications. All this makes us a reliable supplier and development partner.

Comprehensive services complete our offering: SICK LifeTime Services provide support throughout the machine life cycle and ensure safety and productivity.

For us, that is “Sensor Intelligence.”

WORLDWIDE PRESENCE:

Contacts and other locations –www.sick.com