



power contactor, AC-3e/AC-3 185 A, 90 kW / 400 V U_c: 24 V DC x (0.7-1.25) PLC input 24-110 V DC 3-pole, auxiliary contacts 2 NO + 2 NC drive: electronic main circuit: busbar control and auxiliary circuit: screw terminal extended rated condition railroad IEC 60077

product brand name	SIRIUS
product designation	Power contactor
design of the product	With extended operating range
product type designation	3RT1
General technical data	
size of contactor	S6
product extension	
• function module for communication	No
• auxiliary switch	Yes
power loss [W] for rated value of the current	
• at AC in hot operating state	39 W
• at AC in hot operating state per pole	13 W
• without load current share typical	2.8 W
type of calculation of power loss current-dependent	quadratic
insulation voltage	
• of main circuit with degree of pollution 3 rated value	1 000 V
• of auxiliary circuit with degree of pollution 3 rated value	500 V
surge voltage resistance	
• of main circuit rated value	8 kV
• of auxiliary circuit rated value	6 kV
maximum permissible voltage for protective separation between coil and main contacts according to EN 60947-1	690 V
shock resistance for railway applications according to EN 61373	Category 1, Class B
shock resistance at rectangular impulse	
• at DC	8,5 g / 5 ms, 4,2 g / 10 ms
shock resistance with sine pulse	
• at DC	13,4 g / 5 ms, 6,5 g / 10 ms
mechanical service life (operating cycles)	
• of contactor typical	10 000 000
• of the contactor with added electronically optimized auxiliary switch block typical	5 000 000
• of the contactor with added auxiliary switch block typical	10 000 000
reference code according to IEC 81346-2	Q
Substance Prohibitance (day/month/year)	09/06/2016
SVHC substance name	Lead CAS-No. 7439-92-1 Lead monoxide (lead oxide) CAS-No. 1317-36-8 2-methyl-1-(4-methylthiophenyl)-2-morpholinopropan-1-one CAS-No. 71868-10-5 Melamine CAS-No. 108-78-1
Net Weight	3.401 kg
Ambient conditions	

installation altitude at height above sea level maximum	2 000 m
ambient temperature	
• during operation	-40 ... +70 °C
• during storage	-55 ... +80 °C
relative humidity minimum	10 %
relative humidity at 55 °C according to IEC 60068-2-30 maximum	95 %
Main circuit	
number of poles for main current circuit	3
number of NO contacts for main contacts	3
number of NC contacts for main contacts	0
operating voltage	
• at AC-3 rated value maximum	1 000 V
• at AC-3e rated value maximum	1 000 V
operational current	
• at AC-1 at 400 V at ambient temperature 40 °C rated value	215 A
• at AC-1	
— up to 690 V at ambient temperature 40 °C rated value	215 A
— up to 690 V at ambient temperature 60 °C rated value	185 A
— up to 1000 V at ambient temperature 60 °C rated value	100 A
• at AC-2 at 400 V rated value	185 A
• at AC-3	
— at 400 V rated value	185 A
— at 500 V rated value	185 A
— at 690 V rated value	170 A
— at 1000 V rated value	65 A
• at AC-3e	
— at 400 V rated value	185 A
— at 500 V rated value	185 A
— at 690 V rated value	170 A
— at 1000 V rated value	65 A
• at AC-4 at 400 V rated value	160 A
minimum cross-section in main circuit	
• at maximum AC-1 rated value	95 mm ²
• at maximum Ith rated value	95 mm ²
operational current for approx. 200000 operating cycles at AC-4	
• at 400 V rated value	81 A
• at 690 V rated value	65 A
operational current	
• at 1 current path at DC-1	
— at 24 V rated value	160 A
— at 110 V rated value	18 A
— at 220 V rated value	3.4 A
— at 440 V rated value	0.8 A
— at 600 V rated value	0.5 A
• with 2 current paths in series at DC-1	
— at 24 V rated value	160 A
— at 110 V rated value	160 A
— at 220 V rated value	20 A
— at 440 V rated value	3.2 A
— at 600 V rated value	1.6 A
• with 3 current paths in series at DC-1	
— at 24 V rated value	160 A
— at 110 V rated value	160 A
— at 220 V rated value	160 A
— at 440 V rated value	11.5 A

<ul style="list-style-type: none"> — at 600 V rated value 	4 A
<ul style="list-style-type: none"> ● at 1 current path at DC-3 at DC-5 <ul style="list-style-type: none"> — at 24 V rated value — at 110 V rated value — at 220 V rated value — at 440 V rated value — at 600 V rated value ● with 2 current paths in series at DC-3 at DC-5 <ul style="list-style-type: none"> — at 24 V rated value — at 110 V rated value — at 220 V rated value — at 440 V rated value — at 600 V rated value ● with 3 current paths in series at DC-3 at DC-5 <ul style="list-style-type: none"> — at 24 V rated value — at 110 V rated value — at 220 V rated value — at 440 V rated value — at 600 V rated value 	160 A 2.5 A 0.6 A 0.17 A 0.12 A 160 A 160 A 2.5 A 0.65 A 0.37 A 160 A 160 A 160 A 1.4 A 0.75 A
operating power <ul style="list-style-type: none"> ● at AC-2 at 400 V rated value ● at AC-3 <ul style="list-style-type: none"> — at 230 V rated value — at 400 V rated value — at 500 V rated value — at 690 V rated value — at 1000 V rated value ● at AC-3e <ul style="list-style-type: none"> — at 230 V rated value — at 400 V rated value — at 500 V rated value — at 690 V rated value — at 1000 V rated value 	90 kW 61 kW 90 kW 132 kW 160 kW 90 kW 61 kW 90 kW 132 kW 160 kW 90 kW
operating power for approx. 200000 operating cycles at AC-4 <ul style="list-style-type: none"> ● at 400 V rated value ● at 690 V rated value 	45 kW 65 kW
short-time withstand current in cold operating state up to 40 °C <ul style="list-style-type: none"> ● limited to 1 s switching at zero current maximum ● limited to 5 s switching at zero current maximum ● limited to 10 s switching at zero current maximum ● limited to 30 s switching at zero current maximum ● limited to 60 s switching at zero current maximum 	2 900 A; Use minimum cross-section acc. to AC-1 rated value 2 084 A; Use minimum cross-section acc. to AC-1 rated value 1 480 A; Use minimum cross-section acc. to AC-1 rated value 968 A; Use minimum cross-section acc. to AC-1 rated value 801 A; Use minimum cross-section acc. to AC-1 rated value
no-load switching frequency <ul style="list-style-type: none"> ● at DC 	1 000 1/h
operating frequency <ul style="list-style-type: none"> ● at AC-1 maximum ● at AC-2 maximum ● at AC-3 maximum ● at AC-3e <ul style="list-style-type: none"> — maximum ● at AC-2 at AC-3e maximum ● at AC-4 maximum 	800 1/h 300 1/h 750 1/h 750 1/h 300 1/h 130 1/h
operating frequency <ul style="list-style-type: none"> ● at DC-1 maximum ● at DC-3 maximum ● at DC-5 maximum 	400 1/h 350 1/h 350 1/h
Ratings for railway applications	



thermal current (I_{th}) up to 690 V	
• up to 40 °C according to IEC 60077 rated value	215 A
• up to 70 °C according to IEC 60077 rated value	145 A
Control circuit/ Control	
type of voltage	DC
type of voltage of the control supply voltage	DC
control supply voltage at DC rated value	24 V
operating range factor control supply voltage rated value of magnet coil at DC	
• initial value	0.7
• full-scale value	1.25
consumed current at PLC-control input according to IEC 60947-1 maximum	2 mA
voltage at PLC-control input	24 ... 110 V
design of the surge suppressor	with varistor
closing power of magnet coil at DC	320 W
holding power of magnet coil at DC	2.8 W
closing delay	
• at DC	35 ... 75 ms
opening delay	
• at DC	80 ... 90 ms
arcing time	10 ... 15 ms
control version of the switch operating mechanism	PLC-IN or Standard A1 - A2 (adjustable)
Auxiliary circuit	
number of NC contacts for auxiliary contacts	2
• instantaneous contact	2
number of NO contacts for auxiliary contacts	2
• instantaneous contact	2
operational current at AC-12 maximum	10 A
operational current at AC-15	
• at 230 V rated value	6 A
• at 400 V rated value	3 A
• at 500 V rated value	2 A
operational current at DC-12	
• at 24 V rated value	10 A
• at 48 V rated value	6 A
• at 60 V rated value	6 A
• at 110 V rated value	3 A
• at 125 V rated value	2 A
• at 220 V rated value	1 A
• at 600 V rated value	0.15 A
operational current at DC-13	
• at 24 V rated value	6 A
• at 48 V rated value	2 A
• at 60 V rated value	2 A
• at 110 V rated value	1 A
• at 125 V rated value	0.9 A
• at 220 V rated value	0.3 A
• at 600 V rated value	0.1 A
UL/CSA ratings	
full-load current (FLA) for 3-phase AC motor	
• at 480 V rated value	180 A
• at 600 V rated value	192 A
yielded mechanical performance [hp]	
• for single-phase AC motor	
— at 230 V rated value	230 hp
• for 3-phase AC motor	
— at 200/208 V rated value	60 hp
— at 220/230 V rated value	75 hp

— at 460/480 V rated value	150 hp
— at 575/600 V rated value	200 hp
contact rating of auxiliary contacts according to UL	A600 / Q600
Short-circuit protection	
design of the miniature circuit breaker for short-circuit protection of the auxiliary circuit up to 230 V	C characteristic: 10 A; 0.4 kA
design of the fuse link	
<ul style="list-style-type: none"> ● for short-circuit protection of the main circuit <ul style="list-style-type: none"> — with type of coordination 1 required — with type of coordination 2 required ● for short-circuit protection of the auxiliary switch required 	gG: 355 A (690 V, 100 kA) gG: 315 A (690 V, 100 kA), aM: 200 A (690 V, 50 kA), BS88: 315 A (415 V, 50 kA) gG: 10 A (500 V, 1 kA)
Installation/ mounting/ dimensions	
mounting position	with vertical mounting surface +/-90° rotatable, with vertical mounting surface +/- 22.5° tiltable to the front and back
fastening method side-by-side mounting	Yes
fastening method	screw fixing
height	172 mm
width	120 mm
depth	170 mm
required spacing	
<ul style="list-style-type: none"> ● with side-by-side mounting <ul style="list-style-type: none"> — forwards — upwards — downwards — at the side ● for grounded parts <ul style="list-style-type: none"> — forwards — upwards — at the side — downwards ● for live parts <ul style="list-style-type: none"> — forwards — upwards — downwards — at the side 	20 mm 10 mm 10 mm 10 mm 20 mm 10 mm 10 mm 10 mm 20 mm 10 mm 10 mm 10 mm
Connections/ Terminals	
type of electrical connection	
<ul style="list-style-type: none"> ● for main current circuit ● for auxiliary and control circuit 	screw-type terminals screw-type terminals
width of connection bar	17 mm
thickness of connection bar	3 mm
diameter of holes	9 mm
number of holes	1
type of connectable conductor cross-sections	
<ul style="list-style-type: none"> ● for main contacts <ul style="list-style-type: none"> — solid or stranded ● for AWG cables for main contacts 	max. 1x 50, 1x 70 mm ² 2x 1/0
type of connectable conductor cross-sections	
<ul style="list-style-type: none"> ● for auxiliary contacts <ul style="list-style-type: none"> — solid — solid or stranded — finely stranded with core end processing ● for AWG cables for auxiliary contacts 	2x (0.5 ... 1.5 mm ²), 2x (0.75 ... 2.5 mm ²), max. 2x (0.75 ... 4 mm ²) 2x (0.5 ... 1.5 mm ²), 2x (0.75 ... 2.5 mm ²), max. 2x (0.75 ... 4 mm ²) 2x (0.5 ... 1.5 mm ²), 2x (0.75 ... 2.5 mm ²) 2x (20 ... 16), 2x (18 ... 14), 1x 12
AWG number as coded connectable conductor cross section for auxiliary contacts	18 ... 14
Safety related data	
product function	
<ul style="list-style-type: none"> ● mirror contact according to IEC 60947-4-1 ● positively driven operation according to IEC 60947-5-1 	Yes No

• suitable for safety function	Yes
suitability for use safety-related switching OFF	Yes; safety-related disconnection via A1 A2
service life maximum	20 a
test wear-related service life necessary	Yes
proportion of dangerous failures	
• with low demand rate according to SN 31920	40 %
• with high demand rate according to SN 31920	73 %
B10 value with high demand rate according to SN 31920	1 000 000
failure rate [FIT] with low demand rate according to SN 31920	100 FIT
ISO 13849	
device type according to ISO 13849-1	3
overdimensioning according to ISO 13849-2 necessary	Yes
IEC 61508	
safety device type according to IEC 61508-2	Type A
Electrical Safety	
protection class IP on the front according to IEC 60529	IP00; IP20 with box terminal/cover
touch protection on the front according to IEC 60529	finger-safe, for vertical contact from the front with box terminal/cover
Communication/ Protocol	
product function bus communication	No

Approvals Certificates

Environment	General Product Approval				
Environmental Conformations					

General Product Approval	EMV	Functional Safety	Test Certificates		
			Type Examination Certificate	Type Test Certificates/Test Report	Special Test Certificate

other	Railway				
Miscellaneous	Miscellaneous	Confirmation		Miscellaneous	Special Test Certificate

Railway
Type Test Certificates/Test Report

Further information

- Information on the packaging
<https://support.industry.siemens.com/cs/ww/en/view/109813875>
- Information for data generation and storage
<https://support.industry.siemens.com/cs/ww/en/view/109995012>
- Information- and Downloadcenter (Catalogs, Brochures,...)
<https://www.siemens.com/ic10>
- Industry Mall (Online ordering system)
<https://mall.industry.siemens.com/mall/en/en/Catalog/product?mlfb=3RT1056-6XB46-0LA2>
- Service&Support (Manuals, Certificates, Characteristics, FAQs,...)
<https://support.industry.siemens.com/cs/ww/en/ps/3RT1056-6XB46-0LA2>
- Image database (product images, 2D dimension drawings, 3D models, device circuit diagrams, EPLAN macros, ...)
https://www.automation.siemens.com/bilddb/cax_de.aspx?mlfb=3RT1056-6XB46-0LA2&lang=en

Cax online generator

<https://support.automation.siemens.com/WW/CAXorder/default.aspx?lang=en&mfb=3RT1056-6XB46-0LA2>

Characteristic curves

https://curves.simaris.siemens.com/curves/<mmp_prod_noCOMP='HAUPT'></mmp_prod_no>

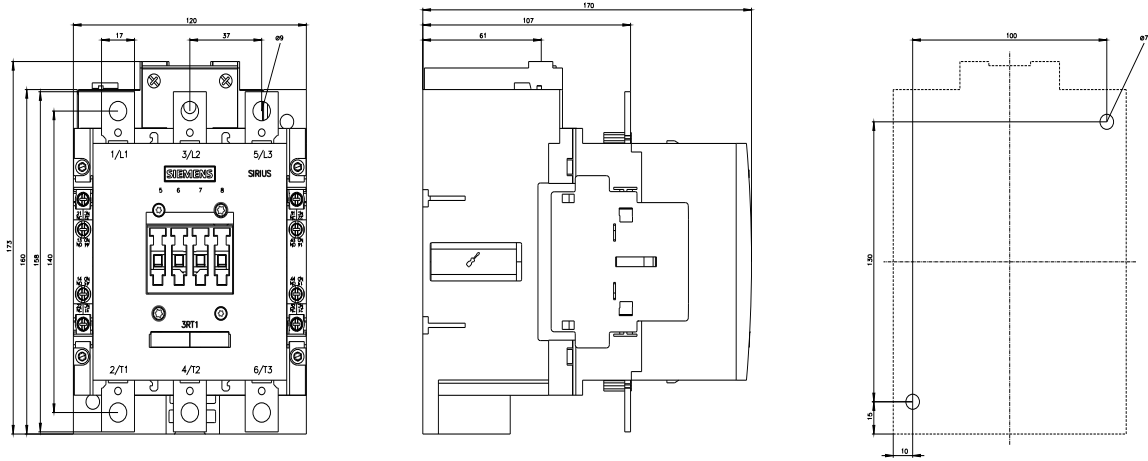

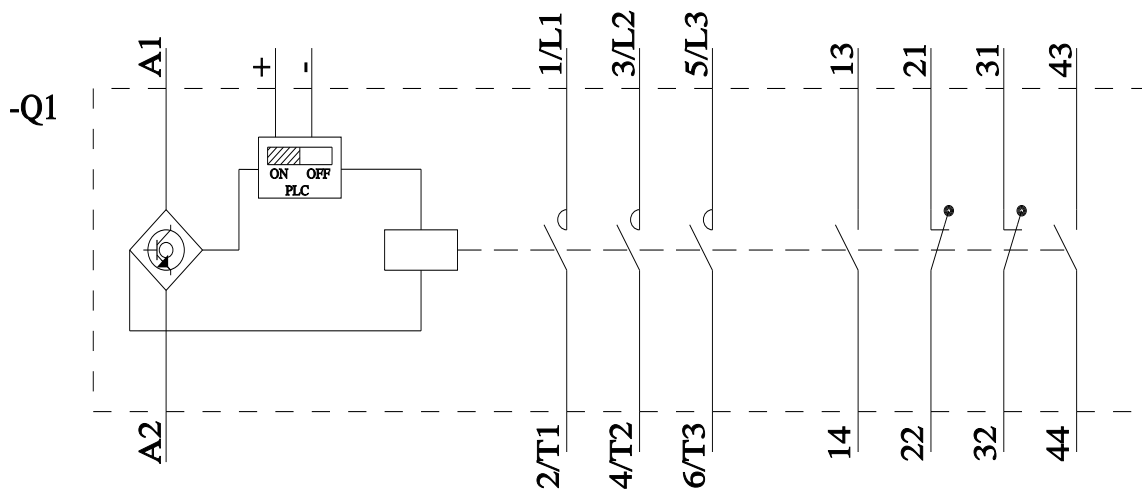

last modified:

5/29/2026 